

54xxxxA



CHRYSsafidis

XHTONG[®]



ISO9001:2008



ISO14001:2004



OHSAS18001:2007



PICC
PRODUCTS LIABILITY
INSURANCE POLICY'S SCHEDULE



潍坊鑫汇通金属制品有限公司
WEIFANG XINHUITONG METAL WORK CO., LTD



ISO9001:2008



ISO14001:2004



OHSAS18001:2007

PRODUCTS LIABILITY
INSURANCE POLICY'S SCHEDULE

公司简介

Company Profile >



丹麦迪砂 (DISA) 自动生产线

潍坊鑫汇通金属制品有限公司是一家集研发、生产、销售、工程服务为一体的综合性高新技术企业，专业从事沟槽管件的研发与制造，年生产能力3万吨以上，在同行业中名列前茅。

公司位于风景秀丽的世界风筝都—山东潍坊，北临G20济青高速公路，南临309国道，厂房占地面积50000多平方米，地理位置优越，交通十分便利。

公司的球墨铸铁沟槽管件完全按照美国ASTM标准生产，先后通过了中国国家型式检验、CCCF认证和美国FM、UL等认证，并由中国人民保险公司承保。产品广泛应用于消防、空调、给水、污水、水泥、低压蒸气、矿坑管路系列及一般管路输送，目前遍布欧洲、美洲等世界各地，深受国内外用户的好评。

公司技术力量雄厚，具备世界一流的设备和工艺，以及完善的质量检测手段。目前拥有世界上最先进的美国应达 (Inductotherm Group) 变频感应电炉、丹麦迪砂 (DISA) 自动生产线、德国爱立许 (EIRICH) 自动浇注机、立式数控加工中心数台、静电喷塑流水线、浸漆流水线条数，拥有标准化型砂实验室、理化实验室，配备进口的光谱分析仪、金相显微镜、拉力试验机、拉伸试验机、橡胶老化箱等先进的检测设备。

公司建立了完善的质量管理体系，先后通过了GB/T19001—2008 / ISO9001: 2008、GB/T28001—2011 / OHSAS18001:2007、GB/T24001—2004 / ISO14001:2004 认证。坚持以人为本，全员参与，把下道工序当作顾客，保证向顾客提供符合要求的产品和服务，最大限度地提高客户满意度。“以质量求生存，靠信誉求发展”是我们一贯坚持的理念，潍坊鑫汇通金属制品有限公司愿为广大客户提供优质的产品与服务。



Weifang Xinhuitong Metal Work Co.,Ltd. is a high-tech enterprise that integrates R&D, production, marketing, and engineering service. The company specializes in the R&D and manufacturing of grooved pipe fittings. Its annual production capacity is well above 30,000 tons, which is far ahead of all others in this field.

The company locates in Weifang, Shandong province, a beautiful city known as "the world capital of kites". It is adjacent to the G20 Jinan-Qingdao Highway in the north, and is closed to China National Highway 309 (G309) in the south. The factory and its supporting facilities cover an area of more than 50,000 square meters, enjoying a good geographical location and extremely convenient transportation.

The company's spheroidal graphite cast iron grooved pipe fittings are manufactured in full accordance with the ASTM standards, having successively passed the China national type test and the certification of FM, UL, etc., and are underwritten by PICC property and casualty company limited. The products are widely used in fire fighting, air-conditioning, water supply, sewage, cement, low-pressure steaming, mine piping and ordinary piping delivery, spreading all over the world including Europe and America at present and winning the appreciations from users domestic and overseas.

The company has strong technical strength, and possesses the world's first-class equipment and technology, as well as perfect testing measures. At present, we own the world's most advanced Inductotherm Group frequency converted induction furnace, Denmark DISA automatic production line, Germany EIRICH automatic pouring machine, several vertical CNC machining centers, electrostatic spray production line, and paint dipping production lines, have the standard molding sand laboratory and the physical & chemical laboratory, and are furnished with the advanced testing equipment like the imported spectrometer, metaloscope, tension tester, cupping machine, rubber aging box, etc..

The company has established a perfect quality management system in compliance with the requirements of GB/T19001-2008 / ISO9001:2008 standard. It insists on the concept of "People-oriented, total-staff participation", treats the next working procedure as customer, ensures to provide customers with satisfactory products and services, and maximize the customers' satisfaction. Adhering to the idea of "Survive on quality, develop on credibility" Xinhuitong Metal Work Co.,Ltd. is willing and always ready to provide our clients with top-quality products and best services.



ISO9001:2008

ISO14001:2004

OHSAS18001:2007

PRODUCTS LIABILITY
INSURANCE POLICY'S SCHEDULE

产品图例

Product Legend >



XGQT1 刚性卡箍 Rigid Coupling	XGQT1H 高压刚性卡箍 High Pressure Rigid Coupling	XGQT2 挠性卡箍 Flexible Coupling	XGQT2H 高压挠性卡箍 High Pressure Flexible Coupling	XGQT5 斜卡 Angle Holder	XGQT6 异径管卡 Reducing Coupling	XGQT7 肩型管接头 Shouldered Flexible Coupling	XGQT8 环形管接头 Ring Joint coupling
--	---	---	--	------------------------------------	---	---	--



XGQT01 90°弯头 90° Elbow	XGQT01S 丝接异径 90 度弯头 Reducing Elbow Grooved×Grooved	XGQT01G 沟槽异径 90 度弯头 Grooved Elbow Grooved×Threaded	XGQT01D 排水弯头 Drainage Elbow	XGQT01H 异径排水弯头 Reducing Drainage Elbow	XGQT02 45°弯头 45° Elbow	XGQT021 22.5°弯头 22.5° Elbow	XGQT022 11.25°弯头 11.25° Elbow
-------------------------------------	--	--	--	--	-------------------------------------	--	--



XGQT07 沟槽同心异径管 Grooved Concentric Reducer	XGQT07S 螺纹同心异径管 Threaded Concentric Reducer	XGQT11 沟槽偏心异径管 Grooved Eccentric Reducer	XGQT11S 丝接偏心异径管 Threaded Eccentric Reducer	XGQT4 分体法兰 Grooved Split Flange
---	---	--	--	--



XGQT08 转换法兰 Grooved Adaptor Flange	XGQT08S 丝接法兰 Threaded Flange	XGQT09 盲片 End Cap	XGQT09L 盲片 End Cap	XGQT10 偏心带孔盲片 End Cap with Eccentric Hole	XGQT10C 同心带孔盲片 End Cap with Concentric Hole
---	---	--------------------------------	---------------------------------	---	--



Red
(红色)

Orange
(桔黄)

White
(白色)

Blue(白硅)
(蓝色)

Black
(黑色)

Green
(绿色)



Painted
(浸漆)

Epoxy
(涂塑)

Galvanized
(镀锌)

Dacromet
(达克罗)

PE-RTH
(衬塑)

PE-RTH
(衬塑)



XGQT3S

螺纹机械三通

Threaded Out Let Mechanical Tee

XGQT3

沟槽机械三通

Grooved Out Let Mechanical Tee

XGQT3S

U型栓机三

U-bolted Mechanical Tee

XGQT3T

机械四通

Mechanical Cross

XGQT03

正三通

Equal Tee

XGQT05

沟槽异径三通

Grooved Reducing Tee

XGQT05S

螺纹异径三通

Threaded Reducing Tee



XGQT05E

中大三通

Bullhead Tee

TY05

沟槽异径顺水三通

Reducing Pitcher Tee

Y03

正Y型三通

Ture-Y

TY06

沟槽异径顺水四通

Reducing Pitcher Cross

XGQT04

正四通

Equal Cross

XGQT06

沟槽异径四通

Grooved Reducing Cross

XGQT06S

螺纹异径四通

Threaded Reducing Cross

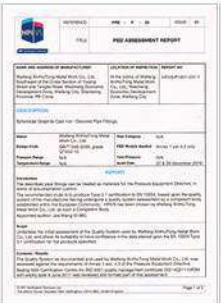

XGQT1
刚性卡箍
Rigid Coupling

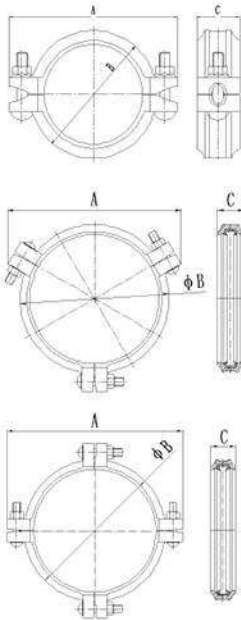

Nominal size 规格	Pipe O.D mm/in	Working Pressure Mpa/psi	Dimension mm/in			Bolt/Nut 螺栓 / 螺母
			A	B	C	
25 1	33.7 1.315	2.07 300	98	58	45	M10*50
32 1¼	42.4 1.66	2.07 300	106	68	45	M10*50
40 1½	48.3 1.9	2.07 300	112	73	45	M10*50
50 2	60.3 2.375	2.07 300	128	86	45	M10*55
65 2½	73 2.875	2.07 300	138	96	45	M10*55
65 2½	76.1 3	2.07 300	139	99	45	M10*55
80 3	88.9 3.5	2.07 300	158	112	45	M10*60
100 4	114.3 4.5	2.07 300	192	143	50	2-M12*70
125 5	139.7 5.5	2.07 300	223	169	50	2-M12*75
125 5	141.3 5.563	2.07 300	223	169	50	2-M12*75
150 6	165.1 6.5	2.07 300	252	198	50	2-M12*75
150 6	168.3 6.625	2.07 300	252	200	50	2-M12*75
200 8	216.3 8.516	2.07 300	326	252	60	2-M16*90
200 8	219.1 8.625	2.07 300	322	254	58	2-M16*90
250 10	267.4 10.528	2.07 300	384	309	62	2-M20*100
250 10	273 10.75	2.07 300	388	314	62	2-M20*110
300 12	318.5 12.539	2.07 300	440	362	62	2-M20*110
300 12	323.9 12.75	2.07 300	443	365	62	2-M20*110
350 14	355.6 14.000	2.07 300	510	415	72	3-M22*140
350 14	377.0 14.850	2.07 300	535	435	72	3-M22*140
400 16	406.4 16.000	2.07 300	575	468	72	3-M22*140
400 16	426.0 16.770	1.60 225	592	490	72	3-M22*140
450 18	457.2 18.000	1.60 225	608	508	78	3-M22*140
450 18	480.0 18.898	1.60 225	630	533	78	3-M22*140
500 20	508.0 20.000	1.60 225	660	563	78	4-M22*140
500 20	530.0 20.866	1.60 225	700	595	78	4-M22*140
600 24	609.6 24.000	1.60 225	772	668	78	4-M24*140
600 24	630 24.80	1.60 225	796	692	78	4-M24*140



ISO9001:2008 ISO14001:2004 OHSAS18001:2007

PRODUCTS LIABILITY
INSURANCE POLICY'S SCHEDULE

XGQT1H

高压刚性卡箍

High Pressure Rigid Coupling

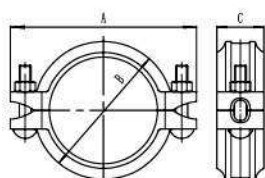

Nominal size 规格	Pipe O.D mm/in 钢管尺寸	Working Pressure Mpa/psi 工作压力	Dimension mm/in			Bolt/Nut 螺栓 / 螺母
			A	B	C	
25 1	33.7 1.315	3.45 500	98	58	45	M10*50
32 1¼	42.4 1.66	3.45 500	106	68	45	M10*50
40 1½	48.3 1.9	3.45 500	112	73	45	M10*50
50 2	60.3 2.375	3.45 500	128	86	45	M10*55
65 2½	73 2.875	3.45 500	138	96	45	M10*55
65 2½	76.1 3	3.45 500	139	99	45	M10*55
80 3	88.9 3.5	3.45 500	158	112	45	M10*60
100 4	114.3 4.5	3.45 500	192	143	50	2-M12*75
125 5	139.7 5.5	3.45 500	223	169	50	2-M12*75
125 5	141.3 5.563	3.45 500	223	169	50	2-M12*75
150 6	165.1 6.5	3.45 500	252	198	50	2-M12*75
150 6	168.3 6.625	3.45 500	252	200	50	2-M12*75
200 8	216.3 8.516	3.45 500	326	252	60	2-M16*90
200 8	219.1 8.625	3.45 500	336	259	60	2-M20*110
250 10	267.4 10.528	3.45 500	384	309	62	2-M20*100
250 10	273 10.75	3.45 500	388	314	62	2-M20*110
300 12	318.5 12.539	3.45 500	440	362	62	2-M20*110
300 12	323.9 12.75	3.45 500	452	370	64	2-M20*130

XGQT2
挠性卡箍
Flexible Coupling

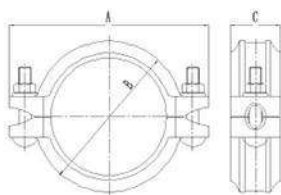

Nominal size 规格	Pipe O.D mm/in 钢管尺寸	Working Pressure Mpa/psi 工作压力	Dimension mm/in			Bolt/Nut 螺栓 / 螺母
			A	B	C	
25 1	33.7 1.315	2.07 300	98	58	45	M10*50
32 1¼	42.4 1.66	2.07 300	106	68	45	M10*50
40 1½	48.3 1.9	2.07 300	112	73	45	M10*50
50 2	60.3 2.375	2.07 300	128	86	45	M10*55
65 2½	73 2.875	2.07 300	138	96	45	M10*55
65 2½	76.1 3	2.07 300	139	99	45	M10*55
80 3	88.9 3.5	2.07 300	158	112	45	M10*60
100 4	114.3 4.5	2.07 300	192	143	50	2-M12*70
125 5	139.7 5.5	2.07 300	223	169	50	2-M12*75
125 5	141.3 5.563	2.07 300	223	169	50	2-M12*75
150 6	165.1 6.5	2.07 300	252	198	50	2-M12*75
150 6	168.3 6.625	2.07 300	252	200	50	2-M12*75
200 8	216.3 8.516	2.07 300	326	252	60	2-M16*90
200 8	219.1 8.625	2.07 300	322	254	58	2-M16*90
250 10	267.4 10.528	2.07 300	384	309	62	2-M20*100
250 10	273 10.75	2.07 300	388	314	62	2-M20*110
300 12	318.5 12.539	2.07 300	440	362	62	2-M20*110
300 12	323.9 12.75	2.07 300	443	365	62	2-M20*110



PRODUCTS LIABILITY
INSURANCE POLICY SCHEDULE

ISO9001:2008 ISO14001:2004 OHSAS18001:2007

XGQT2H

高压挠性卡箍

High Pressure Flexible Coupling

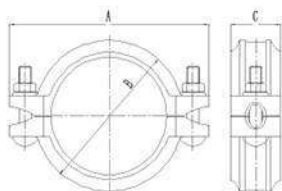

Nominal size 规格	Pipe O.D mm/in 钢管尺寸	Working Pressure Mpa/psi 工作压力	Dimension mm/in			Bolt/Nut 螺栓 / 螺母
			A	B	C	
25	33.7	3.45				
1	1.315	500	98	58	45	M10*50
32	42.4	3.45				
1 1/4	1.66	500	106	68	45	M10*50
40	48.3	3.45				
1 1/2	1.9	500	112	73	45	M10*50
50	60.3	3.45				
2	2.375	500	128	86	45	M10*55
65	73	3.45				
2 1/2	2.875	500	138	96	45	M10*55
65	76.1	3.45				
2 1/2	3	500	139	99	45	M10*55
80	88.9	3.45				
3	3.5	500	158	112	45	M10*60
100	114.3	3.45				
4	4.5	500	192	143	50	2-M12*75
125	139.7	3.45				
5	5.5	500	223	169	50	2-M12*75
125	141.3	3.45				
5	5.563	500	223	169	50	2-M12*75
150	165.1	3.45				
6	6.5	500	252	198	50	2-M12*75
150	168.3	3.45				
6	6.625	500	252	200	50	2-M12*75
200	216.3	3.45				
8	8.516	500	326	252	60	2-M16*90
200	219.1	3.45				
8	8.625	500	336	259	60	2-M20*110
250	267.4	3.45				
10	10.528	500	384	309	62	2-M20*100
250	273	3.45				
10	10.75	500	388	314	62	2-M20*110
300	318.5	3.45				
12	12.539	500	440	362	62	2-M20*110
300	323.9	3.45				
12	12.75	500	452	370	64	2-M20*130

XGQT5

斜卡

Angle Holder

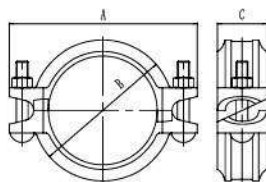

Nominal size 规格	Pipe O.D mm/in 钢管尺寸	Working Pressure Mpa/psi 工作压力	Dimension mm/in			Bolt/Nut 螺栓 / 螺母
			A	B	C	
25	33.7	2.07				
1	1.315	300	98	58	45	M10*50
32	42.4	2.07				
1 1/4	1.66	300	106	68	45	M10*50
40	48.3	2.07				
1 1/2	1.9	300	112	73	45	M10*50
50	60.3	2.07				
2	2.375	300	128	86	45	M10*55
65	73	2.07				
2 1/2	2.875	300	138	96	45	M10*55
65	76.1	2.07				
2 1/2	3	300	139	99	45	M10*55
80	88.9	2.07				
3	3.5	300	158	112	45	M10*60
100	114.3	2.07				
4	4.5	300	192	143	50	2-M12*70
125	139.7	2.07				
5	5.5	300	223	169	50	2-M12*75
125	141.3	2.07				
5	5.563	300	223	169	50	2-M12*75
150	165.1	2.07				
6	6.5	300	252	198	50	2-M12*75
150	168.3	2.07				
6	6.625	300	252	200	50	2-M12*75
200	216.3	2.07				
8	8.516	300	326	252	60	2-M16*90
200	219.1	2.07				
8	8.625	300	336	259	60	2-M20*110
250	267.4	2.07				
10	10.528	300	384	309	62	2-M20*100
250	273	2.07				
10	10.75	300	388	314	62	2-M20*110
300	318.5	2.07				
12	12.539	300	440	362	62	2-M20*110
300	323.9	2.07				
12	12.75	300	452	370	64	2-M20*130

XGQT6
异径管卡
Reducing Coupling

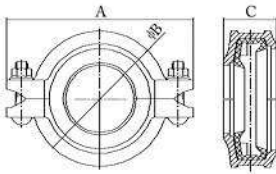

Nominal size	Pipe O.D mm/in	Working Pressure Mpa/psi	Dimension mm/in			Bolt/Nut	Nominal size	Pipe O.D mm/in	Working Pressure Mpa/psi	Dimension mm/in			Bolt/Nut
			A	B	C					A	B	C	
32*25 1 1/4"	42.4*33.7 1.66*1.327	2.07 300	106	67	45	2-M10*50	100*80 4*3	114.3*88.9 4.5*3.5	2.07 300	194	146	48	2-M12*65
40*25 1 1/2"	48.3*33.7 1.9*1.327	2.07 300	114	74	45	2-M10*50	125*50 5*2	139.7*60.3 5.5*2.375	2.07 300	222	170	48	2-M12*75
40*32 1 1/2"	48.3*42.4 1.9*1.66	2.07 300	114	74	45	2-M10*50	125*65 5*2 1/2	139.7*76.1 5.5*3	2.07 300	222	170	48	2-M12*75
50*25 2"	60.3*33.7 2.375*1.327	2.07 300	128	86	45	2-M10*50	125*80 5*3	139.7*88.9 5.5*3.5	2.07 300	222	170	48	2-M12*75
50*32 2"	60.3*42.4 2.375*1.66	2.07 300	128	86	45	2-M10*50	125*100 5*4	139.7*114.3 5.5*4.5	2.07 300	222	170	50	2-M12*75
60*40 2 1/2"	60.3*48.3 2.375*1.9	2.07 300	128	86	45	2-M10*50	125*50 5*2	141.3*60.3 5.563*2.375	2.07 300	222	172	48	2-M12*75
65*25 2 1/2"	73*33.7 2.875*1.327	2.07 300	146	104	45	2-M10*55	125*65 5*2 1/2	141.3*73 5.563*2.875	2.07 300	222	172	48	2-M12*75
65*32 2 1/2"	73*42.4 2.875*1.66	2.07 300	146	104	45	2-M10*55	125*80 5*3	141.3*88.9 5.563*3.5	2.07 300	222	172	48	2-M12*75
65*40 2 1/2"	73*48.3 2.875*1.9	2.07 300	146	104	45	2-M10*55	125*100 5*4	141.3*114.3 5.563*4.5	2.07 300	222	172	50	2-M12*75
65*50 2 1/2"	73*60.3 2.875*2.375	2.07 300	146	104	45	2-M10*55	150*65 6*2 1/2	165.1*76.1 6.5*3	2.07 300	252	196	50	2-M16*85
65*25 2 1/2"	76.1*33.7 3*1.327	2.07 300	146	104	45	2-M10*55	150*80 6*3	165.1*88.9 6.5*3.5	2.07 300	252	196	50	2-M16*85
65*32 2 1/2"	76.1*42.4 3*1.66	2.07 300	146	104	45	2-M10*55	150*100 6*4	165.1*114.3 6.5*4.5	2.07 300	252	196	50	2-M16*85
65*40 2 1/2"	76.1*48.3 3*1.9	2.07 300	146	104	45	2-M10*55	150*125 6*5	165.1*139.7 6.5*5.5	2.07 300	252	196	50	2-M16*85
65*50 2 1/2"	76.1*60.3 3*2.375	2.07 300	146	104	45	2-M10*55	150*50 6*2	168.3*60.3 6.625*2.375	2.07 300	262	208	49	2-M16*85
80*25 3"	88.9*33.7 3.5*1.315	2.07 300	160	116	45	2-M10*55	150*80 6*3	168.3*88.9 6.625*3.5	2.07 300	262	208	49	2-M16*85
80*32 3"	88.9*42.4 3.5*1.66	2.07 300	160	116	45	2-M10*55	150*100 6*4	168.3*114.3 6.625*4.5	2.07 300	262	208	50	2-M16*85
80*40 3"	88.9*48.3 3.5*1.9	2.07 300	160	116	45	2-M10*55	150*125 6*5	168.3*139.7 6.625*5.5	2.07 300	262	208	50	2-M16*85
80*50 3"	88.9*60.3 3.5*2.375	2.07 300	160	116	45	2-M10*55	150*125 6*5	168.3*141.3 6.625*5.563	2.07 300	262	208	50	2-M16*85
80*65 3 1/2"	88.9*73 3.5*2.875	2.07 300	160	116	45	2-M10*55	200*50 8*2	219.1*60.3 8.625*2.375	2.07 300	336	255	58	2-M20*100
80*65 3 1/2"	88.9*76.1 3.5*3	2.07 300	160	116	45	2-M10*55	200*80 8*3	219.1*88.9 8.625*3.5	2.07 300	336	255	58	2-M20*100
100*25 4"	114.3*33.7 4.5*1.315	2.07 300	194	146	48	2-M12*65	200*100 8*4	219.1*114.3 8.625*4.5	2.07 300	336	255	60	2-M20*100
100*32 4"	114.3*42.4 4.5*1.66	2.07 300	194	146	48	2-M12*65	200*125 8*5	219.1*139.7 8.625*5.5	2.07 300	336	255	60	2-M20*100
100*40 4"	114.3*48.3 4.5*1.9	2.07 300	194	146	48	2-M12*65	200*125 8*5	219.1*141.3 8.625*5.563	2.07 300	336	255	60	2-M20*100
100*50 4"	114.3*60.3 4.5*2.375	2.07 300	194	146	48	2-M12*65	200*150 8*6	219.1*165.1 8.625*6.5	2.07 300	336	255	60	2-M20*100
100*65 4 1/2"	114.3*73 4.5*2.875	2.07 300	194	146	48	2-M12*65	200*150 8*6	219.1*168.3 8.625*6.625	2.07 300	336	255	60	2-M20*100
100*65 4 1/2"	114.3*76.1 4.5*3	2.07 300	194	146	48	2-M12*65							



ISO9001:2008 ISO14001:2004 OHSAS18001:2007

PRODUCTS LIABILITY INSURANCE POLICY'S SCHEDULE

XGQT7

肩型管接头

Shouldered Flexible Coupling

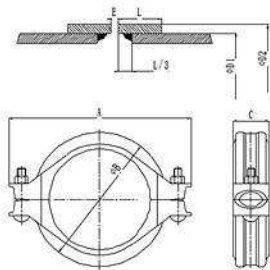

Nominal size	Pipe O.D D1 mm/in	Working Pressure Mpa/psi	Dimension mm/in			Bolt/Nut	Shoulder O.D mm/in D1	Shoulder Length mm/in L	Nominal Gap mm/in E
			A	B	C				
40	48.3	4.14	112	73	45	2-M10*50	52	12.5	3.2
1½	1.9	600					2.047	0.492	0.125
50	60.3	4.14	128	86	45	2-M10*55	66.5	16	3.2
2	2.375	600					2.628	0.625	0.125
65	73	4.14	138	96	45	2-M10*55	80	13	3.2
2½	2.875	600					3.15	0.512	0.125
65	76.1	4.14	139	99	45	2-M10*55	83	13	3.2
2½	3	600					3.268	0.512	0.125
80	88.9	4.14	158	112	45	2-M10*60	97	16	3.2
3	3.5	600					3.819	0.625	0.125
90	101.6	4.14	208	140	46	2-M10*60	108	15.5	3.2
3½	4	600					4.252	0.61	0.125
100	114.3	4.14	192	143	50	2-M12*75	122	17.5	3.2
4	4.5	600					4.803	0.688	0.125
125	139.7	4.14	223	169	50	2-M12*75	148.5	17.5	3.2
5	5.5	600					5.84	0.688	0.125
125	141.3	4.14	223	169	50	2-M12*75	150	17.5	3.2
5	5.563	600					5.91	0.688	0.125
150	165.1	4.14	252	198	50	2-M12*75	174.5	17.5	3.2
6	6.5	600					6.87	0.688	0.125
150	168.3	4.14	252	200	50	2-M12*75	178	17.5	3.2
6	6.625	600					7.007	0.688	0.125
200	216.3	4.14	326	252	60	2-M16*90	229	20.6	3.2
8	8.516	600					9.02	0.813	0.125
200	219.1	4.14	336	259	60	2-M20*110	232	20.6	3.2
8	8.625	600					9.134	0.813	0.125
250	267.4	4.14	384	309	62	2-M20*100	280	20.6	3.2
10	10.528	600					11.02	0.813	0.125
250	273	4.14	388	314	62	2-M20*110	286	20.6	3.2
10	10.75	600					11.26	0.813	0.125
300	318.5	4.14	440	362	62	2-M20*110	331	20.6	3.2
12	12.539	600					13.03	0.813	0.125
300	323.9	4.14	452	370	64	2-M20*130	336.5	20.6	3.2
12	12.75	600					13.248	0.813	0.125

XGQT8

环形管接头

Ring Joint Coupling

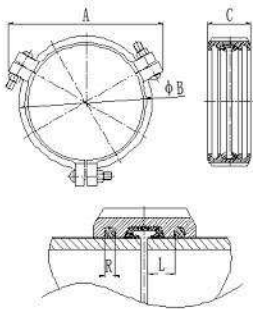

Nominal size	Pipe O.D mm/in	Working Pressure Mpa/psi	Dimension mm/in					Bolt/Nut	Nominal size	Pipe O.D mm/in	Working Pressure Mpa/psi	Dimension mm/in					Bolt/Nut
规格	钢管尺寸	工作压力	A	B	C	L	R	螺栓 / 螺母	规格	钢管尺寸	工作压力	A	B	C	L	R	螺栓 / 螺母
200	219.1	2.76	330	256	79	23	6.0	2-M20x120	900	914.4	2.76	1103	1010	200	50	12.7	12-M22x90
8	8.625	400							36	36	400						
250	273.0	2.76	386	312	83	23	6.0	2-M20x120	950	965.2	2.76	1156	1060	200	50	12.7	12-M22x90
10	10.75	400							38	38	400						
300	323.9	2.76	455	374	86	26	8.0	2-M20x120	1000	1016.0	2.76	1229	1135	200	60	15.9	16-M30x130
12	12.75	400							40	40	400						
200	216.3	2.76	327	253	79	23	6.0	2-M20x120	1050	1066.8	2.76	1288	1186	200	60	15.9	16-M30x130
8	8.516	400							42	42	400						
250	267.4	2.76	380	306	83	23	6.0	2-M20x120	1100	1117.6	2.76	1337	1236	200	60	15.9	16-M30x130
10	10.528	400							44	44	400						
300	318.5	2.76	450	369	86	26	8.0	2-M20x120	1200	1219.2	2.76	1420	1338	200	60	15.9	16-M30x130
12	12.539	400							48	48	400						
350	355.6	2.76	493	405	93	26	8.0	2-M22x140	1300	1320.8	2.76	1541	1555	200	60	15.9	16-M30x130
14	14	400							52	52	400						
400	406.4	2.76	547	455	93	26	8.0	2-M22x140	1350	1371.6	2.76	1588	1607	200	60	15.9	16-M30x130
16	16	400							54	54	400						
450	457.2	2.76	614	517	107	30	8.0	2-M24x140	1400	1422.4	2.76	1643	1660	200	60	15.9	16-M30x130
18	18	400							56	56	400						
500	508.1	2.76	660	570	110	30	9.5	2-M24x140	1500	1524.0	2.76	1748	1762	200	60	15.9	16-M30x130
20	20	400							60	60	400						
600	609.6	2.76	762	690	123	30	12.7	4-M24x140	1650	1676.4	2.76	1924	1932	216	60	19.1	16-M30x130
24	24	400							66	66	400						
650	660.4	2.76	832	751	170	50	12.7	4-M24x140	1700	1727.2	2.76	1982	1994	216	60	19.1	16-M30x130
26	26	400							68	68	400						
700	711.2	2.76	901	806	170	50	12.7	12-M22x90	1800	1828.8	2.76	2090	2095	216	60	19.1	16-M30x130
28	28	400							72	72	400						
750	762.0	2.76	955	857	170	50	12.7	12-M22x90	2100	2133.6	2.76	2383	2406	216	60	19.1	16-M30x130
30	30	400							84	84	400						
800	812.8	2.76	1002	908	170	50	12.7	12-M22x90	2400	2438.4	2.76	106.54	106.75				16-M30x130
32	32	400							96	96	400	2706	2711	216	60	19.1	
850	863.4	2.76	1054	959	200	50	12.7	12-M22x90									
34	34	400															



PRODUCTS LIABILITY
INSURANCE POLICY'S SCHEDULE

XGQT3S-U

U型栓机三

U-bolted Mechanical Tee

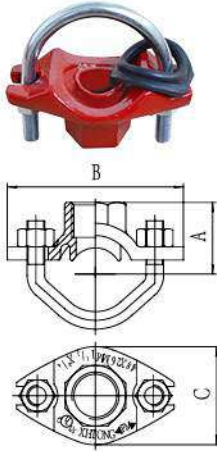

Nominal size	Pipe O.D mm/in	Working Pressure Mpa/psi	Dimension mm/in			Hole Dia mm/in	Bolt size
			A	B	C		
25*15 1*1/2	33.7*21.3 1.327*0.825	2.07 300	39	84	50	25 1	M10*53
25*20 1*3/4	33.7*26.9 1.327*1.05	2.07 300	45	84	50	25 1	M10*53
32*15 1*1/2	42.4*21.3 1.669*0.825	2.07 300	40	90	56	30 1.18	M10*53
32*20 1*3/4	42.4*26.9 1.669*1.05	2.07 300	42	90	56	30 1.18	M10*53
32*25 1*1	42.4*33.7 1.669*1.327	2.07 300	52	90	56	30 1.18	M10*53
40*15 1*1/2	48.3*21.3 1.9*0.825	2.07 300	45	90	56	30 1.18	M10*63
40*20 1*3/4	48.3*26.9 1.9*1.05	2.07 300	45	90	56	30 1.18	M10*63
40*25 1*1	48.3*33.7 1.9*1.327	2.07 300	55	90	56	30 1.18	M10*63
50*15 2*1/2	60.3*21.3 2.375*0.825	2.07 300	50	95	56	30 1.18	M10*76
50*20 2*3/4	60.3*26.9 2.375*1.05	2.07 300	50	95	56	30 1.18	M10*76
50*25 2*1	60.3*33.7 2.375*1.327	2.07 300	60	95	56	30 1.18	M10*76
65*15 2*1/2	73*21.3 2.875*0.825	2.07 300	57	112	56	30 1.18	M10*92
65*20 2*3/4	73*26.9 2.875*1.05	2.07 300	58	112	56	30 1.18	M10*92
65*25 2*1	73*33.7 2.875*1.327	2.07 300	68	112	56	30 1.18	M10*92
65*15 2*1/2	76.1*21.3 3*0.825	2.07 300	57	112	56	30 1.18	M10*92
65*20 2*3/4	76.1*26.9 3*1.05	2.07 300	58	112	56	30 1.18	M10*92
65*25 2*1	76.1*33.7 3*1.327	2.07 300	68	112	56	30 1.18	M10*92

XGQT3S

螺纹机械三通

Threaded Out Let
Mechanical Tee

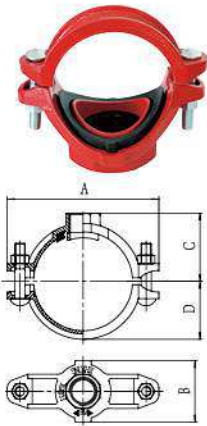

Nominal size	Pipe O.D mm/in	Working Pressure Mpa/psi	Dimension mm/in				Hole Dia mm/in	Bolt Size
规格	钢管尺寸	工作压力	A	B	C	D	开孔尺寸	螺栓规格
50*25 2*1	60.3*33.7 2.375*1.327	2.07 300	118	73	49	38	38	2-M10*60
50*32 2*1½	60.3*42.4 2.375*1.669	2.07 300	118	73	52	38	46	2-M10*60
50*40 2*1	60.3*48.3 2.375*1.9	2.07 300	118	73	62	38	46	2-M10*60
65*15 2½	73*21.3 2.875*0.84	2.07 300	134	56	57	44	30	2-M10*60
65*20 2½	73*26.7 2.875*1.05	2.07 300	134	56	57	44	30	2-M10*60
5*25 2½	73*33.7 2.875*1.315	2.07 300	134	72	57	44	38	2-M10*60
65*32 2½	73*42.4 2.875*1.669	2.07 300	134	82	58	44	46	2-M10*60
65*40 2½	73*48.3 2.875*1.9	2.07 300	134	84	58	44	53	2-M10*60
65*50 2½	73*60.3 2.875*2.375	2.07 300	134	84	74	44	53	2-M10*60
65*15 2½	76.1*21.3 3*0.84	2.07 300	136	72	59	48	30	2-M10*60
65*20 2½	76.1*26.7 3*1.05	2.07 300	136	56	59	48	30	2-M10*60
65*25 2½	76.1*33.7 3*1.327	2.07 300	136	56	59	48	38	2-M10*60
65*32 2½	76.1*42.4 3*1.669	2.07 300	136	82	60	48	46	2-M10*60
65*40 2½	76.1*48.3 3*1.9	2.07 300	136	84	60	48	53	2-M10*60
65*50 2½	76.1*60.3 3*2.375	2.07 300	136	84	76	48	53	2-M10*60
80*15 3	88.9*21.3 3.5*0.84	2.07 300	144	70	68	55	38	2-M10*60
80*20 3	88.9*26.7 3.5*1.05	2.07 300	144	70	68	55	38	2-M10*60
80*25 3	88.9*33.7 3.5*1.327	2.07 300	144	72	66	55	38	2-M10*60
80*32 3	88.9*42.4 3.5*1.669	2.07 300	144	83	67	55	46	2-M10*60
80*40 3	88.9*48.3 3.5*1.9	2.07 300	144	85	67	55	53	2-M10*60
80*50 3	88.9*60.3 3.5*2.375	2.07 300	144	98	69	55	64	2-M10*60
80*65 3	88.9*73 3.5*2.875	2.07 300	144	98	87	55	64	2-M10*60
80*65 3	88.9*76.1 3.5*3	2.07 300	144	98	87	55	64	2-M10*60
100*25 4	108*33.7 4.25*1.327	2.07 300	168	72	76	64	38	2-M12*65

Nominal size	Pipe O.D mm/in	Working Pressure Mpa/psi	Dimension mm/in				Hole Dia mm/in	Bolt Size
规格	钢管尺寸	工作压力	A	B	C	D	开孔尺寸	螺栓规格
100*32 4	108*42.4 4.25*1.669	2.07 300	168	83	76	64	46	2-M12*65
100*40 4	108*48.3 4.25*1.9	2.07 300	168	85	76	64	53	2-M12*65
100*50 4	108*60.3 4.25*2.375	2.07 300	168	95	78	64	64	2-M12*65
100*65 4	108*76.1 4.25*3	2.07 300	168	115	82	64	80	2-M12*65
100*15 4	114.3*21.3 4.5*0.84	2.07 300	178	72	80	68	38	2-M12*65
100*20 4	114.3*26.7 4.5*1.05	2.07 300	178	72	80	68	38	2-M12*65
100*25 4	114.3*33.7 4.5*1.327	2.07 300	178	72	80	68	38	2-M12*65
100*32 4	114.3*42.4 4.5*1.669	2.07 300	178	83	80	68	46	2-M12*65
100*40 4	114.3*48.3 4.5*1.9	2.07 300	178	84	80	68	53	2-M12*65
100*50 4	114.3*60.3 4.5*2.375	2.07 300	178	95	82	68	64	2-M12*65
100*65 4	114.3*73 4.5*2.875	2.07 300	178	114	82	68	80	2-M12*65
100*65 4	114.3*76.1 4.5*3	2.07 300	178	114	82	68	80	2-M12*65
100*80 4	114.3*88.9 4.5*3.5	2.07 300	178	126	95	68	92	2-M12*65
125*25 5	133*33.7 5.25*1.327	2.07 300	198	72	90	79	38	2-M12*75
125*32 5	133*42.4 5.25*1.669	2.07 300	198	83	90	79	46	2-M12*75
125*40 5	133*48.3 5.25*1.9	2.07 300	198	85	90	79	53	2-M12*75
125*50 5	133*60.3 5.25*2.375	2.07 300	198	95	92	79	64	2-M12*75
125*65 5	133*76.1 5.25*3	2.07 300	198	114	92	79	80	2-M12*75
125*80 5	133*88.9 5.25*3.5	2.07 300	198	126	96	79	92	2-M12*75
125*25 5	139.7*33.7 5.5*1.327	2.07 300	206	72	93	81	38	2-M12*75
125*32 5	139.7*42.4 5.5*1.669	2.07 300	206	83	93	81	46	2-M12*75
125*40 5	139.7*48.3 5.5*1.9	2.07 300	206	85	93	81	53	2-M12*75
125*50 5	139.7*60.3 5.5*2.375	2.07 300	206	95	95	81	64	2-M12*75
125*65 5	139.7*73 5.5*2.875	2.07 300	206	114	95	81	80	2-M12*75



PRODUCTS LIABILITY
INSURANCE POLICY'S SCHEDULE

XGQT3S

螺纹机械三通

Threaded Out Let
Mechanical Tee

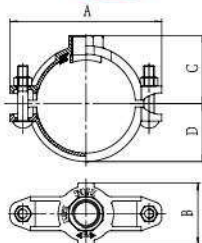

Nominal size	Pipe O.D mm/in	Working Pressure Mpa/psi	Dimension mm/in				Hole Dia mm/in	Bolt Size
			A	B	C	D		
125*65 5"2"	139.7*76.1 5.5"3	2.07 300	206	114	95	81	80	2-M12*75
125*80 5"3	139.7*88.9 5.5"3.5	2.07 300	206	128	95	81	92	2-M12*75
125*100 5"4	139.7*114.3 5.5"4.5	2.07 300	208	157	117	81	114	2-M12*75
125*25 5"1	141.3*33.7 5.563"1.327	2.07 300	206	72	93	82	38	2-M12*75
125*32 5"1 1/4	141.3*42.4 5.563"1.669	2.07 300	206	83	93	82	46	2-M12*75
125*40 5"1 1/2	141.3*48.3 5.563"1.9	2.07 300	206	85	93	82	53	2-M12*75
125*50 5"2	141.3*60.3 5.563"2.375	2.07 300	206	95	95	82	64	2-M12*75
125*65 5"2 1/2	141.3*73 5.563"2.875	2.07 300	206	114	95	82	80	2-M12*75
125*65 5"2 1/2	141.3*76.1 5.563"3	2.07 300	206	114	95	82	80	2-M12*75
125*80 5"3	141.3*88.9 5.563"3.5	2.07 300	206	128	95	82	92	2-M12*75
125*100 5"4	141.3*114.3 5.563"4.5	2.07 300	208	157	117	82	114	2-M12*75
150*25 6"1	159*33.7 6.25"1.327	2.07 300	228	72	105	90	38	2-M12*75
150*32 6"1 1/4	159*42.4 6.25"1.669	2.07 300	228	83	105	90	46	2-M12*75
150*40 6"1 1/2	159*48.3 6.25"1.9	2.07 300	228	85	105	90	53	2-M12*75
150*50 6"2	159*60.3 6.25"2.375	2.07 300	228	95	108	90	64	2-M12*75
150*65 6"2 1/2	159*76.1 6.25"3	2.07 300	228	115	108	90	80	2-M12*75
150*80 6"3	159*88.9 6.25"3.5	2.07 300	228	128	108	90	92	2-M12*75
150*100 6"4	159*114.3 6.25"4.5	2.07 300	228	158	117	90	114	2-M12*75
150*15 6" 1/2	165*21.3 6.5"0.84	2.07 300	242	72	105	93	38	2-M14*75
150*20 6" 3/4	165*26.7 6.5"1.06	2.07 300	242	72	105	93	38	2-M14*75
150*25 6"1	165.1*33.7 6.5"1.327	2.07 300	242	72	105	93	38	2-M14*75
150*32 6"1 1/4	165.1*42.4 6.5"1.669	2.07 300	242	83	105	93	46	2-M14*75
150*40 6"1 1/2	165.1*48.3 6.5"1.9	2.07 300	242	85	105	93	53	2-M14*75
150*50 6"2	165.1*60.3 6.5"2.375	2.07 300	242	95	108	93	64	2-M14*75
150*65 6"2 1/2	165.1*76.1 6.5"3	2.07 300	242	115	108	93	80	2-M14*75

Nominal size	Pipe O.D mm/in	Working Pressure Mpa/psi	Dimension mm/in				Hole Dia mm/in	Bolt Size
			A	B	C	D		
150*80 6"3	165.1*88.9 6.5"3.5	2.07 300	242	128	108	93	92	2-M14*75
150*100 6"4	165.1*114.3 6.5"4.5	2.07 300	242	158	112	93	114	2-M14*75
150*15 6" 1/2	168.3*21.3 6.625"0.84	2.07 300	248	72	109	96	38	2-M14*75
150*20 6" 3/4	168.3*26.7 6.625"1.06	2.07 300	248	72	109	96	38	2-M14*75
150*25 6"1	168.3*33.7 6.625"1.327	2.07 300	248	72	111	96	38	2-M14*75
150*32 6"1 1/4	168.3*42.4 6.625"1.669	2.07 300	248	83	111	96	46	2-M14*75
150*40 6"1 1/2	168.3*48.3 6.625"1.9	2.07 300	248	85	111	96	53	2-M14*75
150*50 6"2	168.3*60.3 6.625"2.375	2.07 300	248	95	111	96	64	2-M14*75
150*65 6"2 1/2	168.3*73 6.625"2.875	2.07 300	248	115	111	96	80	2-M14*75
150*65 6"2 1/2	168.3*76.1 6.625"3	2.07 300	248	115	111	96	80	2-M14*75
150*80 6"3	168.3*88.9 6.625"3.5	2.07 300	248	128	111	96	92	2-M14*75
150*100 6"4	168.3*114.3 6.625"4.5	2.07 300	248	158	116	96	114	2-M14*75
200*25 8"1	219*33.7 8.625"1.327	2.07 300	298	75	134	122	38	2-M16*85
200*32 8"1 1/4	219*42.4 8.625"1.669	2.07 300	298	82	137	122	46	2-M16*85
200*40 8"1 1/2	219*48.3 8.625"1.9	2.07 300	298	86	137	122	53	2-M16*85
200*50 8"2	219*60.3 8.625"2.375	2.07 300	298	98	137	122	64	2-M16*85
200*65 8"2 1/2	219*73 8.625"2.875	2.07 300	298	115	137	122	80	2-M16*85
200*65 8"2 1/2	219*76.1 8.625"3	2.07 300	298	115	137	122	80	2-M16*85
200*80 8"3	219*88.9 8.625"3.5	2.07 300	298	128	139	122	92	2-M16*85
200*100 8"4	219*114.3 8.625"4.5	2.07 300	298	156	154	122	114	2-M16*85
250*50 10"2	273*60 10.75"2.375	2.07 300	372	100	168	151	64	2-M20*110
250*65 10"2 1/2	273*73 10.75"2.875	2.07 300	372	115	168	151	80	2-M20*110
250*65 10"2 1/2	273*76 10.75"3	2.07 300	372	115	168	151	80	2-M20*110
250*65 10"3	273*89 10.75"3.5	2.07 300	372	128	169	151	92	2-M20*110
250*65 10"4	273*114 10.75"4.5	2.07 300	372	160	182	151	114	2-M20*110

XGQT3

沟槽机械三通
Grooved Out Let
Mechanical Tee

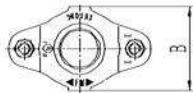
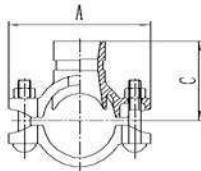

Nominal size	Pipe O.D mm/in	Working Pressure Mpa/psi	Dimension mm/in				Hole Dia mm/in	Bolt Size
			A	B	C	D		
50*25 2"1	60.3*33.7 2.375*1.315	2.07 300	118	73	66	38	38	2-M10*80
50*32 2"1 1/2	60.3*42.4 2.375*1.669	2.07 300	118	73	66	38	46	2-M10*80
50*40 2"1 1/4	60.3*48.3 2.375*1.9	2.07 300	118	73	66	38	46	2-M10*80
65*25 2 1/2	73*33.7 2.875*1.315	2.07 300	136	72	76	46	38	2-M10*80
65*32 2 1/2 1/4	73*42.4 2.875*1.669	2.07 300	136	82	77	46	46	2-M10*80
65*40 2 1/2 1/2	73*48.3 2.875*1.9	2.07 300	136	84	77	46	53	2-M10*80
65*50 2 1/2 3/4	73*60.3 2.875*2.375	2.07 300	136	84	77	46	53	2-M10*80
65*25 2 1/2	76.1*33.7 3*1.315	2.07 300	136	72	76	48	38	2-M10*80
65*32 2 1/2 1/4	76.1*42.4 3*1.669	2.07 300	136	82	77	48	46	2-M10*80
65*40 2 1/2 1/2	76.1*48.3 3*1.9	2.07 300	136	84	77	48	53	2-M10*80
65*50 2 1/2 3/4	76.1*60.3 3*2.375	2.07 300	136	84	77	48	53	2-M10*80
80*25 3"1	88.9*33.7 3.5*1.315	2.07 300	144	72	83	55	38	2-M10*80
80*32 3"1 1/2	88.9*42.4 3.5*1.669	2.07 300	144	83	85	55	46	2-M10*80
80*40 3"1 1/4	88.9*48.3 3.5*1.9	2.07 300	144	85	85	55	53	2-M10*80
80*50 3"2	88.9*60.3 3.5*2.375	2.07 300	144	98	85	55	64	2-M10*80
80*65 3"2 1/2	88.9*73 3.5*2.875	2.07 300	144	98	85	55	64	2-M10*80
80*85 3"2 3/4	88.9*76.1 3.5*3	2.07 300	144	98	85	55	64	2-M10*80
100*25 4"1	114.3*33.7 4.5*1.315	2.07 300	178	72	98	68	38	2-M12*65
100*32 4"1 1/2	114.3*42.4 4.5*1.669	2.07 300	178	83	98	68	46	2-M12*65
100*40 4"1 1/4	114.3*48.3 4.5*1.9	2.07 300	178	85	98	68	53	2-M12*65
100*50 4"2	114.3*60.3 4.5*2.375	2.07 300	178	95	98	68	64	2-M12*65
100*65 4"2 1/2	114.3*73 4.5*2.875	2.07 300	178	114	98	68	80	2-M12*65
100*85 4"3	114.3*76.1 4.5*3	2.07 300	178	114	98	68	80	2-M12*65
100*80 4"3	114.3*88.9 4.5*3.5	2.07 300	178	126	98	68	92	2-M12*65
125*25 5"1	139.7*33.7 5.5*1.315	2.07 300	206	72	109	81	38	2-M12*75
125*32 5"1 1/2	139.7*42.4 5.5*1.669	2.07 300	206	83	109	81	46	2-M12*75
125*40 5"1 1/4	139.7*48.3 5.5*1.9	2.07 300	206	85	109	81	53	2-M12*75
125*50 5"2	139.7*60.3 5.5*2.375	2.07 300	206	95	109	81	64	2-M12*75
125*65 5"2 1/2	139.7*73 5.5*2.875	2.07 300	206	114	109	81	80	2-M12*75
125*85 5"3	139.7*76.1 5.5*3	2.07 300	206	114	109	81	80	2-M12*75
125*80 5"3	139.7*88.9 5.5*3.5	2.07 300	206	128	109	81	92	2-M12*75
125*25 5"1	141.3*33.7 5.563*1.315	2.07 300	206	72	109	82	38	2-M12*75
125*32 5"1 1/2	141.3*42.4 5.563*1.669	2.07 300	206	83	109	82	46	2-M12*75
125*40 5"1 1/4	141.3*48.3 5.563*1.9	2.07 300	206	85	109	82	53	2-M12*75

Nominal size	Pipe O.D mm/in	Working Pressure Mpa/psi	Dimension mm/in				Hole Dia mm/in	Bolt Size
			A	B	C	D		
125*50 5"2	141.3*60.3 5.563*2.375	2.07 300	206	95	109	82	64	2-M12*75
125*65 5"2 1/2	141.3*73 5.563*2.875	2.07 300	206	115	109	82	80	2-M12*75
125*65 5"2 1/2	141.3*76.1 5.563*3	2.07 300	206	115	109	82	80	2-M12*75
125*80 5"3	141.3*88.9 5.563*3.5	2.07 300	206	128	109	82	92	2-M12*75
150*25 6"1	165.1*33.7 6.5*1.315	2.07 300	242	72	121	93	38	2-M14*75
150*32 6"1 1/2	165.1*42.4 6.5*1.669	2.07 300	242	83	121	93	46	2-M14*75
150*40 6"1 1/4	165.1*48.3 6.5*1.9	2.07 300	242	85	121	93	53	2-M14*75
150*50 6"2	165.1*60.3 6.5*2.375	2.07 300	242	95	121	93	64	2-M14*75
150*65 6"2 1/2	165.1*73 6.5*2.875	2.07 300	242	115	121	93	80	2-M14*75
150*65 6"2 1/2	165.1*76.1 6.5*3	2.07 300	242	115	123	93	80	2-M14*75
150*80 6"3	165.1*88.9 6.5*3.5	2.07 300	242	128	124	93	92	2-M14*75
150*100 6"4	165.1*114.3 6.5*4.5	2.07 300	242	158	121	93	114	2-M14*75
150*25 6"1	168.3*33.7 6.625*1.315	2.07 300	248	72	124	96	38	2-M14*75
150*32 6"1 1/2	168.3*42.4 6.625*1.669	2.07 300	248	83	124	96	46	2-M14*75
150*40 6"1 1/4	168.3*48.3 6.625*1.9	2.07 300	248	85	124	96	53	2-M14*75
150*50 6"2	168.3*60.3 6.625*2.375	2.07 300	248	95	124	96	64	2-M14*75
150*65 6"2 1/2	168.3*73 6.625*2.875	2.07 300	248	115	124	96	80	2-M14*75
150*65 6"2 1/2	168.3*76.1 6.625*3	2.07 300	248	115	124	96	80	2-M14*75
150*80 6"3	168.3*88.9 6.625*3.5	2.07 300	248	128	124	96	92	2-M14*75
150*100 6"4	168.3*114.3 6.625*4.5	2.07 300	248	158	124	96	114	2-M14*75
200*25 8"1	219*33.7 8.625*1.315	2.07 300	298	72	152	122	38	2-M16*85
200*32 8"1 1/2	219*42.4 8.625*1.669	2.07 300	298	83	152	122	46	2-M16*85
200*40 8"1 1/4	219*48.3 8.625*1.9	2.07 300	298	85	152	122	53	2-M16*85
200*50 8"2	219*60.3 8.625*2.375	2.07 300	298	95	152	122	64	2-M16*85
200*65 8"2 1/2	219*73 8.625*2.875	2.07 300	298	115	152	122	80	2-M16*85
200*65 8"2 1/2	219*76.1 8.625*3	2.07 300	298	115	152	122	80	2-M16*85
200*80 8"3	219*88.9 8.625*3.5	2.07 300	298	128	152	122	92	2-M16*85
200*100 8"4	219*114.3 8.625*4.5	2.07 300	298	158	152	122	114	2-M16*85
250*50 10"2	273*60.3 10.75*2.375	2.07 300	372	100	180	151	38	2-M20*110
250*65 10"2 1/2	273*73 10.75*2.875	2.07 300	372	115	180	151	80	2-M20*110
250*65 10"2 1/2	273*76.1 10.75*3	2.07 300	372	115	180	151	80	2-M20*110
250*80 10"3	273*88.9 10.75*3.5	2.07 300	372	128	180	151	92	2-M20*110
250*100 10"4	273*108 10.75*4.252	2.07 300	372	158	182	151	114	2-M20*110
250*100 10"4	273*114.3 10.75*4.5	2.07 300	372	160	182	151	114	2-M20*110



PRODUCTS LIABILITY
INSURANCE POLICY'S SCHEDULE

ISO9001:2008 ISO14001:2004 OHSAS18001:2007

XGQT01

90°弯头

90° Elbow

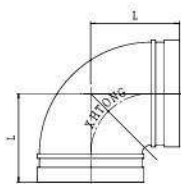

Nominal size 规格	Pipe O.D mm/in 钢管尺寸	Working Pressure Mpa/psi 工作压力	Dimension mm/in L		
25 1	33.7 1.315	2.07 300		57	57
32 1¼	42.4 1.66	2.07 300		60	70
40 1½	48.3 1.9	2.07 300		60	70
50 2	60.3 2.375	2.07 300	65	70	83
65 2½	73 2.875	2.07 300		76	95
65 2½	76.1 3	2.07 300	76	76	95
80 3	88.9 3.5	2.07 300	80	86	108
100 4	108 4.252	2.07 300	96	102	127
100 4	114.3 4.5	2.07 300	96	102	127
125 5	133 5.25	2.07 300	110	122	140
125 5	139.7 5.5	2.07 300	110	122	140
125 5	141.3 5.563	2.07 300		122	140
150 6	159 6.26	2.07 300	122	140	165
150 6	165.1 6.5	2.07 300	122	140	165
150 6	168.3 6.625	2.07 300	125	140	165
200 8	216.3 8.516	2.07 300		175	197
200 8	219.1 8.625	2.07 300	155	175	197
250 10	267.4 10.528	2.07 300		215	229
250 10	273 10.75	2.07 300	190	215	229
300 12	318.5 12.539	2.07 300		245	254
300 12	323.9 12.75	2.07 300	220	245	254
350 14	355.6 14.000	2.07 300			279
350 14	377.0 14.84	2.07 300			279
400 16	406.4 16.000	2.07 300			305
400 16	426.0 16.77	2.07 300			305
450 18	457.2 18.000	2.07 300			394
450 18	480.0 18.90	2.07 300			335
500 20	508.0 20.000	2.07 300			438
600 24	609.6 24.000	2.07 300			508
600 24	630.0 24.80	2.07 300			508

XGQT02

45°弯头
45° Elbow

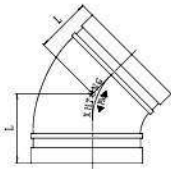

Nominal size	Pipe O.D mm/in	Working Pressure Mpa/psi	Dimension mm/in	
规格	钢管尺寸	工作压力	L	
25	33.7	2.07		45
1	1.315	300		
32	42.4	2.07		45
1¼	1.66	300		
40	48.3	2.07		45
1½	1.9	300		
50	60.3	2.07		51
2	2.375	300		
65	73	2.07	55	57
2½	2.875	300		
65	76.1	2.07	55	57
2½	3	300		
80	88.9	2.07	55	64
3	3.5	300		
100	108	2.07	60	76
4	4.252	300		
100	114.3	2.07	60	76
4	4.5	300		
125	133	2.07	70	83
5	5.25	300		
125	139.7	2.07	70	83
5	5.5	300		
125	141.3	2.07	70	83
5	5.563	300		
150	159	2.07	70	89
6	6.26	300		
150	165.1	2.07	70	89
6	6.5	300		
150	168.3	2.07	70	89
6	6.625	300		
200	216.3	2.07		108
8	8.516	300		
200	219.1	2.07	90	108
8	8.625	300		
250	267.4	2.07		121
10	10.528	300		
250	273	2.07	112	121
10	10.75	300		
300	318.5	2.07		133
12	12.539	300		
300	323.9	2.07	120	133
12	12.75	300		
350	355.6	2.07		122
14	14.000	300		
350	377.0	2.07		122
14	14.84	300		
400	406.4	2.07		184
16	16.000	300		
400	426.0	2.07		184
16	16.77	300		
450	457.2	2.07		203
18	18.000	300		
450	480.0	2.07		203
18	18.90	300		
500	508.0	2.07		229
20	20.000	300		
600	609.6	2.07		280
24	24.000	300		



ISO9001:2008

ISO14001:2004

OHSAS18001:2007

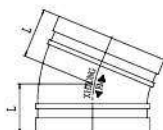
PRODUCTS LIABILITY
INSURANCE POLICY'S SCHEDULE**XGQT021**22.5°弯头
22.5° Elbow

Nominal size 规格	Pipe O.D mm/in 钢管尺寸	Working Pressure Mpa/psi 工作压力	Dimension mm/in L
25	33.7	2.07	40
1	1.315	300	
32	42.4	2.07	45
1¼	1.66	300	
40	48.3	2.07	45
1½	1.9	300	
50	60.3	2.07	45
2	2.375	300	
65	73	2.07	48
2½	2.875	300	
65	76.1	2.07	48
2¾	3	300	
80	88.9	2.07	50
3	3.5	300	
100	108	2.07	50
4	4.252	300	
100	114.3	2.07	73
4	4.5	300	
125	133	2.07	60
5	5.25	300	
125	139.7	2.07	60
5	5.5	300	
125	141.3	2.07	60
5	5.563	300	
150	159	2.07	60
6	6.26	300	
150	165.1	2.07	60
6	6.5	300	
150	168.3	2.07	79
6	6.625	300	
200	219.1	2.07	80
8	8.625	300	
250	273	2.07	90
10	10.75	300	
300	323.9	2.07	102
12	12.75	300	

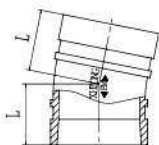
XGQT02211.25°弯头
11.25° Elbow

Nominal size 规格	Pipe O.D mm/in 钢管尺寸	Working Pressure Mpa/psi 工作压力	Dimension mm/in L
25	33.7	2.07	40
1	1.315	300	
32	42.4	2.07	40
1¼	1.66	300	
40	48.3	2.07	35
1½	1.9	300	
50	60.3	2.07	35
2	2.375	300	
65	73	2.07	38
2½	2.875	300	
65	76.1	2.07	38
2¾	3	300	
80	88.9	2.07	38
3	3.5	300	
100	108	2.07	45
4	4.252	300	
100	114.3	2.07	45
4	4.5	300	
125	139.7	2.07	45
5	5.5	300	
125	141.3	2.07	45
5	5.563	300	
150	159	2.07	50
6	6.26	300	
150	165.1	2.07	50
6	6.5	300	
150	168.3	2.07	51
6	6.625	300	
200	219.1	2.07	55
8	8.625	300	
250	273	2.07	55
10	10.75	300	
300	323.9	2.07	57
12	12.75	300	

XGQT01D

排水弯头

Drainage Elbow

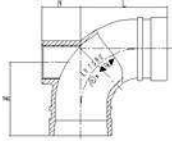

BSPT and NPT threads are also available, please specify when order.

Nominal size 规格	Pipe O.D mm/in 钢管尺寸	Working Pressure Mpa/psi 工作压力	Dimension mm/in		
			L	M	N
50*25 2*1	60.3*33.7 2.375*1.327	2.07 300	70	70	36
65*25 2½*1	73*33.7 2.875*1.327	2.07 300	95	70	44
65*25 2½*1	76.1*33.7 3*1.327	2.07 300	95	70	44
80*25 3*1	88.9*33.7 3.5*1.327	2.07 300	108	70	52
100*25 4*1	114.3*33.7 4.5*1.327	2.07 300	127	70	64
125*25 5*1	139.7*33.7 5.5*1.327	2.07 300	140	70	78
125*25 5*1	141.3*33.7 5.563*1.327	2.07 300	140	70	78
150*25 6*1	165.1*33.7 6.5*1.327	2.07 300	165	70	91
150*25 6*1	168.3*33.7 6.625*1.327	2.07 300	165	70	91
200*25 8*1	219.1*33.7 8.625*1.327	2.07 300	197	70	121

XGQT01H

排水弯头

Reducing
Drainage Elbow

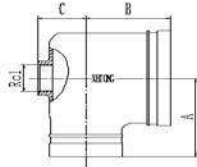

Pipe O.D mm/in 钢管尺寸	Working Pressure MPa/psi 工作压力	Dimension mm		
		A	B	C
114.3*88.9*33.7 4.5*3.5*1.327	2.07 300	95	102	58
165.1*88.9*33.7 6.5*3.5*1.327	2.07 300	130	130	58
168.3*88.9*33.7 6.625*3.5*1.327	2.07 300	130	130	58



ISO9001:2008

ISO14001:2004

OHSAS18001:2007

PRODUCTS LIABILITY
INSURANCE POLICY'S SCHEDULE

XGQT01G

沟槽异径弯头

90° Reducing Elbow

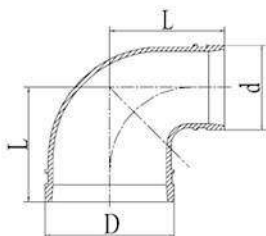

Nominal size 规格	Pipe O.D mm/in 钢管尺寸	Working Pressure Mpa/psi 工作压力	Dimension mm/in L
32*25 1 1/4 * 1	42.4* 33.7 1.66*1.327	2.07 300	70
40*25 1 1/2 * 1	48.3* 33.7 1.9*1.327	2.07 300	70
40*32 1 1/2 * 1 1/4	48.3*42.4 1.9*1.66	2.07 300	70
50*25 2 * 1	60.3* 33.7 2.375*1.327	2.07 300	83
50*32 2 * 1 1/4	60.3*42.4 2.375*1.66	2.07 300	83
60*40 2 * 1 1/2	60.3*48.3 2.375*1.9	2.07 300	83
65*25 2 1/2 * 1	76.1*33.7 3*1.327	2.07 300	95
65*32 2 1/2 * 1 1/4	76.1*42.4 3*1.66	2.07 300	95
65*40 2 1/2 * 1 1/2	76.1*48.3 3*1.9	2.07 300	95
65*50 2 1/2 * 2	76.1*60.3 3*2.375	2.07 300	95
80*25 3 * 1	88.9*33.7 3.5*1.327	2.07 300	108
80*32 3 * 1 1/4	88.9* 42.4 3.5*1.66	2.07 300	108
80*40 3 * 1 1/2	88.9* 48.3 3.5*1.9	2.07 300	108
80*50 3 * 2	88.9* 60.3 3.5*2.375	2.07 300	108
80*65 3 * 2 1/2	88.9* 76.1 3.5*3	2.07 300	108
100*65 4 * 2 1/2	114.3*76.1 4.5*3	2.07 300	127
100*80 4 * 3	114.3*88.9 4.5*3.5	2.07 300	127
150*100 6 * 4	165.1*114.3 6.5*4.5	2.07 300	165
150*100 6 * 4	168.3*114.3 6.625*4.5	2.07 300	165

XGQT01S

丝接异径 90 度弯头

Reducing Elbow
Grooved x Threaded

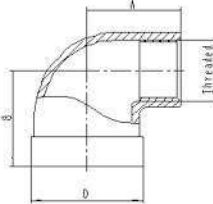

BSPT and NPT threads
are also available, please
specify when order.

Nominal size 规格	Pipe O.D mm/in 钢管尺寸	Working Pressure Mpa/psi 工作压力	Dimension mm/in	
			A	B
25*15 1*1/2	33.7* 21.3 1.327*0.825	2.07 300	44	48
25*20 1*3/4	33.7* 26.7 1.327*1.05	2.07 300	44	48
32*15 1 1/4*1/2	42.4* 21.3 1.66*0.825	2.07 300	46	48
32*20 1 1/4*3/4	42.4* 26.7 1.66*1.05	2.07 300	46	48
32*25 1 1/4*1	42.4*33.7 1.66*1.327	2.07 300	51	52
40*15 1 1/2*1/2	48.3* 21.3 1.9*0.825	2.07 300	46	48
40*20 1 1/2*3/4	48.3* 26.7 1.9*1.05	2.07 300	46	48
40*25 1 1/2*1	48.3*33.7 1.9*1.327	2.07 300	51	52
50*15 2*1/2	60.3* 21.3 2.375*0.825	2.07 300	48	48
50*20 2*3/4	60.3* 26.7 2.375*1.05	2.07 300	48	48
50*25 2*1	60.3*33.7 2.375*1.327	2.07 300	51	52
65*15 2 1/2*1/2	73* 21.3 2.875*0.825	2.07 300	58	48
65*20 2 1/2*3/4	73* 26.7 2.875*1.05	2.07 300	58	48
65*25 2 1/2*1	73*33.7 2.875*1.327	2.07 300	65	55
65*15 2 1/2*1/2	76.1* 21.3 3*0.825	2.07 300	58	48
65*20 2 1/2*3/4	76.1* 26.7 3*1.05	2.07 300	58	48
65*25 2 1/2*1	76.1*33.7 3*1.327	2.07 300	65	55



PRODUCTS LIABILITY
INSURANCE POLICY'S SCHEDULE

ISO9001:2008

ISO14001:2004

OHSAS18001:2007

XGQT03

正三通

Equal Tee

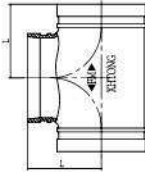

Nominal size 规格	Pipe O.D mm/in 钢管尺寸	Working Pressure Mpa/psi 工作压力	Dimension mm/in L		
25 1	33.7 1.315	2.07 300		57 57	
32 1¼	42.4 1.66	2.07 300		60 70	
40 1½	48.3 1.9	2.07 300		60 70	
50 2	60.3 2.375	2.07 300	70	70 83	
65 2½	73 2.875	2.07 300		76 95	
65 2½	76.1 3	2.07 300	76	76 95	
80 3	88.9 3.5	2.07 300	80	86 108	
100 4	108 4.252	2.07 300	96	102 127	
100 4	114.3 4.5	2.07 300	96	102 127	
125 5	133 5.25	2.07 300	110	122 140	
125 5	139.7 5.5	2.07 300	110	122 140	
125 5	141.3 5.563	2.07 300		122 140	
150 6	159 6.26	2.07 300	122	140 165	
150 6	165.1 6.5	2.07 300	122	140 165	
150 6	168.3 6.625	2.07 300	125	140 165	
200 8	216.3 8.516	2.07 300		175 197	
200 8	219.1 8.625	2.07 300	155	175 197	
250 10	267.4 10.528	2.07 300		215 229	
250 10	273 10.75	2.07 300	190	215 229	
300 12	318.5 12.539	2.07 300		245 254	
300 12	318.5 12.539	2.07 300		245 254	
300 12	323.9 12.75	2.07 300	220	245 254	
350 14	355.6 14.000	2.07 300			279
350 14	377.0 14.84	2.07 300			279
400 16	406.4 16.000	2.07 300			305
400 16	426.0 16.77	2.07 300			305
450 18	457.2 18.000	2.07 300			394
450 18	480.0 18.90	2.07 300			335
500 20	508.0 20.000	2.07 300			438
600 24	609.6 24.000	2.07 300			508



XGQT05
沟槽异径三通
Grooved Reducing Tee

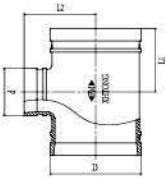

Nominal size	Pipe O.D mm/in	Working Pressure Mpa/psi	Dimension mm/in		Nominal size	Pipe O.D mm/in	Working Pressure Mpa/psi	Dimension mm/in	
			L1	L2				L1	L2
规格	钢管尺寸	工作压力	L1	L2	规格	钢管尺寸	工作压力	L1	L2
80*25 3*1	88.9*33.7 3.5*1.327	2.07 300	65	86	125*50 5*2	139.7*60.3 5.5*2.375	2.07 300	85	122
80*32 3*1½	88.9*42.4 3.5*1.66	2.07 300	70	86	125*65 5*2½	139.7*73 5.5*2.875	2.07 300	85	122
80*40 3*1¾	88.9*48.3 3.5*1.9	2.07 300	70	86	125*65 5*2¾	139.7*76.1 5.5*3	2.07 300	85	122
80*50 3*2	88.9*60.3 3.5*2.375	2.07 300	75	86	125*80 5*3	139.7*88.9 5.5*3.5	2.07 300	100	122
100*25 4*1	108*33.7 4.252*1.327	2.07 300	70	102	125*100 5*4	139.7*108 5.5*4.252	2.07 300	110	122
100*32 4*1¼	108*42.4 4.252*1.66	2.07 300	70	102	125*100 5*4	139.7*114.3 5.5*4.5	2.07 300	110	122
100*40 4*1½	108*48.3 4.252*1.9	2.07 300	75	102	125*25 5*1	141.3*33.7 5.563*1.327	2.07 300	70	122
100*50 4*2	108*60.3 4.252*2.375	2.07 300	85	102	125*32 5*1¼	141.3*42.4 5.563*1.66	2.07 300	70	122
100*65 4*2½	108*76.1 4.252*3	2.07 300	80	95	125*40 5*1½	141.3*48.3 5.563*1.9	2.07 300	75	122
100*80 4*3	108*88.9 4.252*3.5	2.07 300	85	95	125*50 5*2	141.3*60.3 5.563*2.375	2.07 300	85	122
100*25 4*1	114.3*33.7 4.5*1.327	2.07 300	70	102	125*65 5*2½	141.3*73 5.563*2.875	2.07 300	85	122
100*32 4*1¼	114.3*42.4 4.5*1.66	2.07 300	70	102	125*65 5*2¾	141.3*76.1 5.563*3	2.07 300	85	122
100*40 4*1½	114.3*48.3 4.5*1.9	2.07 300	75	102	125*80 5*3	141.3*88.9 5.563*3.5	2.07 300	100	122
100*50 4*2	114.3*60.3 4.5*2.375	2.07 300	85	102	125*100 5*4	141.3*108 5.563*4.252	2.07 300	110	122
100*65 4*2½	114.3*73 4.5*2.875	2.07 300	85	102	125*100 5*4	141.3*114.3 5.563*4.5	2.07 300	110	122
100*65 4*2¾	114.3*76.1 4.5*3	2.07 300	80	95	150*25 6*1	159*33.7 6.25*1.327	2.07 300	70	140
100*80 4*3	114.3*88.9 4.5*3.5	2.07 300	85	95	150*32 6*1¼	159*42.4 6.25*1.66	2.07 300	70	140
125*25 5*1	133*33.7 5.25*1.327	2.07 300	70	122	150*40 6*1½	159*48.3 6.25*1.9	2.07 300	75	140
125*32 5*1¼	133*42.4 5.25*1.66	2.07 300	70	122	150*50 6*2	159*60.3 6.25*2.375	2.07 300	85	140
125*40 5*1½	133*48.3 5.25*1.9	2.07 300	75	122	150*65 6*2½	159*73 6.25*2.875	2.07 300	85	140
125*50 5*2	133*60.3 5.25*2.375	2.07 300	85	122	150*65 6*2¾	159*76.1 6.25*3	2.07 300	85	135
125*65 5*2½	133*73 5.25*2.875	2.07 300	85	122	150*80 6*3	159*88.9 6.25*3.5	2.07 300	100	140
125*65 5*2¾	133*76.1 5.25*3	2.07 300	85	122	150*100 6*4	159*108 6.25*4.252	2.07 300	102	120
125*80 5*3	133*88.9 5.25*3.5	2.07 300	100	122	150*100 6*4	159*114.3 6.25*4.5	2.07 300	102	115
125*100 5*4	133*114.3 5.25*4.5	2.07 300	110	122	150*125 6*5	159*139.7 6.25*5.5	2.07 300	125	140
125*25 5*1	139.7*33.7 5.5*1.327	2.07 300	70	122	150*125 6*5	159*141.3 6.25*5.563	2.07 300	125	140
125*32 5*1¼	139.7*42.4 5.5*1.66	2.07 300	70	115	150*25 6*1	165.1*33.7 6.5*1.327	2.07 300	70	140
125*40 5*1½	139.7*48.3 5.5*1.9	2.07 300	75	122	150*32 6*1¼	165.1*42.4 6.5*1.66	2.07 300	70	130



ISO9001:2008 ISO14001:2004 OHSAS18001:2007

PRODUCTS LIABILITY INSURANCE POLICY'S SCHEDULE

XGQT05

沟槽异径三通

Grooved Reducing Tee

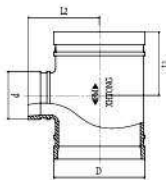

Nominal size	Pipe O.D mm/in	Working Pressure Mpa/psi	Dimension mm/in		Nominal size	Pipe O.D mm/in	Working Pressure Mpa/psi	Dimension mm/in	
			L1	L2				L1	L2
规格	钢管尺寸	工作压力	L1	L2	规格	钢管尺寸	工作压力	L1	L2
150*40	165.1*48.3	2.07	75	140	200*100	219.1*108	2.07	110	170
6*1/2	6.5*1.9	300			8*4	8.625*4.252	300		
150*50	165.1*60.3	2.07	85	140	200*100	219.1*114.3	2.07	110	155
6*2	6.5*2.375	300			8*4	8.625*4.5	300		
150*65	165.1*73	2.07	85	140	200*125	219.1*139.7	2.07	130	175
6*2 1/2	6.5*2.875	300			8*5	8.625*5.5	300		
150*65	165.1*76.1	2.07	80	115	200*125	219.1*141.3	2.07	130	175
6*2 1/2	6.5*3	300			8*5	8.625*5.563	300		
150*80	165.1*88.9	2.07	100	130	200*150	219.1*159	2.07	140	155
6*3	6.5*3.5	300			8*6	8.625*6.25	300		
150*100	165.1*108	2.07	102	120	200*150	219.1*165.1	2.07	140	155
6*4	6.5*4.252	300			8*6	8.625*6.5	300		
150*100	165.1*114.3	2.07	102	115	200*150	219.1*168.3	2.07	140	175
6*4	6.5*4.5	300			8*6	8.625*6.625	300		
150*125	165.1*139.7	2.07	110	125	250*50	273*60.3	2.07	90	197
6*5	6.5*5.5	300			10*2	10.75*2.375	300		
150*125	165.1*141.3	2.07	125	140	250*65	273*73.0	2.07	90	197
6*5	6.5*5.563	300			10*2 1/2	10.75*2.875	300		
150*25	168.3*33.7	2.07	70	140	250*65	273*76.1	2.07	90	197
6*1	6.625*1.327	300			10*2 1/2	10.75*3	300		
150*32	168.3*42.4	2.07	75	135	250*80	273*88.9	2.07	100	197
6*1 1/4	6.625*1.66	300			10*3	10.75*3.5	300		
150*40	168.3*48.3	2.07	75	135	250*100	273*108	2.07	125	210
6*1 1/2	6.625*1.9	300			10*4	10.75*4.252	300		
150*50	168.3*60.3	2.07	85	140	250*100	273*114.3	2.07	125	210
6*2	6.625*2.375	300			10*4	10.75*4.5	300		
150*65	168.3*73	2.07	85	140	250*125	273*139.7	2.07	130	215
6*2 1/2	6.625*2.875	300			10*5	10.75*5.5	300		
150*65	168.3*76.1	2.07	85	135	250*125	273*141.3	2.07	130	215
6*2 1/2	6.625*3	300			10*5	10.75*5.563	300		
150*80	168.3*88.9	2.07	100	140	250*150	273*159	2.07	155	215
6*3	6.625*3.5	300			10*6	10.75*6.25	300		
150*100	168.3*108	2.07	102	120	250*150	273*165.1	2.07	155	210
6*4	6.625*4.252	300			10*6	10.75*6.5	300		
150*100	168.3*114.3	2.07	105	120	250*150	273*168.3	2.07	155	210
6*4	6.625*4.5	300			10*6	10.75*6.625	300		
150*125	168.3*139.7	2.07	125	140	250*200	273*219.1	2.07	190	210
6*5	6.625*5.5	300			10*8	10.75*8.625	300		
150*125	168.3*141.3	2.07	125	140	300*100	323.9*114.3	2.07	125	230
6*5	6.625*5.563	300			12*4	12.75*4.5	300		
200*100	216.3*114.3	2.07	120	165	300*125	323.9*139.7	2.07	130	220
8*4	8.516*4.5	300			12*5	12.75*5.5	300		
200*150	216.3*165.1	2.07	145	175	300*125	323.9*141.3	2.07	130	220
8*6	8.516*6.5	300			12*5	112.75*5.563	300		
200*32	219.1*42.4	2.07	75	155	300*150	323.9*159	2.07	155	230
8*1 1/4	8.625*1.66	300			12*6	12.75*6.25	300		
200*40	219.1*48.3	2.07	75	155	300*150	323.9*165.1	2.07	155	230
8*1 1/2	8.625*1.9	300			12*6	12.75*6.5	300		
200*50	219.1*60.3	2.07	90	155	300*150	323.9*168.3	2.07	155	230
8*2	8.625*2.375	300			12*6	12.75*6.625	300		
200*65	219.1*73	2.07	90	155	300*200	323.9*219.1	2.07	190	235
8*2 1/2	8.625*2.875	300			12*8	12.75*8.625	300		
200*65	219.1*76.1	2.07	90	160	300*250	323.9*273	2.07	220	235
8*2 1/2	8.625*3	300			12*10	12.75*10.75	300		
200*80	219.1*88.9	2.07	100	165					
8*3	8.625*3.5	300							



XGQT05S

螺纹异径三通

Threaded Reducing Tee

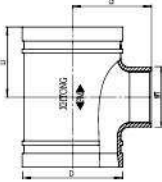

Nominal size	Pipe O.D mm/in	Working Pressure Mpa/psi	Dimension mm/in	
			L1	L2
规格	钢管尺寸	工作压力	L1	L2
80*25 3*1	88.9*33.7 3.5*1.327	2.07 300	70	80
80*32 3*1/4	88.9*42.4 3.5*1.66	2.07 300	75	86
80*40 3*1/2	88.9*48.3 3.5*1.9	2.07 300	70	86
80*50 3*2	88.9*60.3 3.5*2.375	2.07 300	75	86
80*65 3*2 1/2	88.9*76.1 3.5*3	2.07 300	75	75
100*25 4*1	108*33.7 4.252*1.327	2.07 300	70	102
100*32 4*1 1/4	108*42.4 4.252*1.66	2.07 300	70	102
100*40 4*1 1/2	108*48.3 4.252*1.9	2.07 300	75	102
100*50 4*2	108*60.3 4.252*2.375	2.07 300	85	102
100*65 4*2 1/2	108*76.1 4.252*3	2.07 300	85	90
100*80 4*3	108*88.9 4.252*3.5	2.07 300	85	95
100*25 4*1	114.3*33.7 4.5*1.327	2.07 300	70	102
100*32 4*1 1/4	114.3*42.4 4.5*1.66	2.07 300	70	102
100*40 4*1 1/2	114.3*48.3 4.5*1.9	2.07 300	75	102
100*50 4*2	114.3*60.3 4.5*2.375	2.07 300	85	102
100*65 4*2 1/2	114.3*73 4.5*2.875	2.07 300	85	102
100*65 4*2 1/2	114.3*76.1 4.5*3	2.07 300	75	90
100*80 4*3	114.3*88.9 4.5*3.5	2.07 300	85	90
125*25 5*1	133*33.7 5.25*1.327	2.07 300	70	122
125*32 5*1 1/4	133*42.4 5.25*1.66	2.07 300	70	122
125*40 5*1 1/2	133*48.3 5.25*1.9	2.07 300	75	122
125*50 5*2	133*60.3 5.25*2.375	2.07 300	85	122
125*65 5*2 1/2	133*73 5.25*2.875	2.07 300	85	122
125*65 5*2 1/2	133*76.1 5.25*3	2.07 300	85	122
125*80 5*3	133*88.9 5.25*3.5	2.07 300	100	122
125*100 5*4	133*114.3 5.25*4.5	2.07 300	110	122
125*25 5*1	139.7*33.7 5.5*1.327	2.07 300	70	115
125*32 5*1 1/4	139.7*42.4 5.5*1.66	2.07 300	70	122

Nominal size	Pipe O.D mm/in	Working Pressure Mpa/psi	Dimension mm/in	
			L1	L2
规格	钢管尺寸	工作压力	L1	L2
125*40 5*1 1/2	139.7*48.3 5.5*1.9	2.07 300	75	122
125*50 5*2	139.7*60.3 5.5*2.375	2.07 300	85	122
125*65 5*2 1/2	139.7*73 5.5*2.875	2.07 300	85	122
125*65 5*2 1/2	139.7*76.1 5.5*3	2.07 300	85	122
125*80 5*3	139.7*88.9 5.5*3.5	2.07 300	100	122
125*100 5*4	139.7*114.3 5.5*4.5	2.07 300	110	122
125*25 5*1	141.3*33.7 5.563*1.327	2.07 300	70	122
125*32 5*1 1/4	141.3*42.4 5.563*1.66	2.07 300	70	122
125*40 5*1 1/2	141.3*48.3 5.563*1.9	2.07 300	75	122
125*50 5*2	141.3*60.3 5.563*2.375	2.07 300	85	122
125*65 5*2 1/2	141.3*73 5.563*2.875	2.07 300	85	122
125*65 5*2 1/2	141.3*76.1 5.563*3	2.07 300	85	122
125*80 5*3	141.3*88.9 5.563*3.5	2.07 300	100	122
125*100 5*4	141.3*114.3 5.563*4.5	2.07 300	110	122
150*25 6*1	159*33.7 6.25*1.327	2.07 300	70	140
150*32 6*1 1/4	159*42.4 6.25*1.66	2.07 300	70	140
150*40 6*1 1/2	159*48.3 6.25*1.9	2.07 300	75	140
150*50 6*2	159*60.3 6.25*2.375	2.07 300	85	140
150*65 6*2 1/2	159*73 6.25*2.875	2.07 300	85	140
150*65 6*2 1/2	159*76.1 6.25*3	2.07 300	85	135
150*80 6*3	159*88.9 6.25*3.5	2.07 300	100	140
150*100 6*4	159*114.3 6.25*4.5	2.07 300	102	120
150*25 6*1	165.1*33.7 6.5*1.327	2.07 300	70	130
150*32 6*1 1/4	165.1*42.4 6.5*1.66	2.07 300	70	130
150*40 6*1 1/2	165.1*48.3 6.5*1.9	2.07 300	75	130
150*50 6*2	165.1*60.3 6.5*2.375	2.07 300	85	140
150*65 6*2 1/2	165.1*73 6.5*2.875	2.07 300	85	140
150*65 6*2 1/2	165.1*76.1 6.5*3	2.07 300	80	115



PRODUCTS LIABILITY
INSURANCE POLICY SCHEDULE

ISO9001:2008

ISO14001:2004

OHSAS18001:2007

XGQT05S

螺纹异径三通

Threaded Reducing Tee

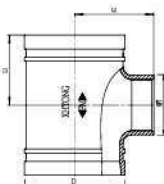

Nominal size	Pipe O.D mm/in	Working Pressure Mpa/psi	Dimension mm/in	
			L1	L2
规格	钢管尺寸	工作压力	L1	L2
150*80 6*3	165.1*88.9 6.5*3.5	2.07 300	100	130
150*100 6*4	165.1*114.3 6.5*4.5	2.07 300	110	140
150*25 6*1	168.3*33.7 6.625*1.327	2.07 300	70	125
150*32 6*1 1/4	168.3*42.4 6.625*1.66	2.07 300	70	130
150*40 6*1 1/2	168.3*48.3 6.625*1.9	2.07 300	75	140
150*50 6*2	168.3*60.3 6.625*2.375	2.07 300	85	140
150*65 6*2 1/2	168.3*73 6.625*2.875	2.07 300	85	140
150*65 6*2 1/2	168.3*76.1 6.625*3	2.07 300	85	135
150*80 6*3	168.3*88.9 6.625*3.5	2.07 300	100	130
150*100 6*4	168.3*114.3 6.625*4.5	2.07 300	110	140
200*32 8*1 1/4	219.1*42.4 8.625*1.66	2.07 300	75	155
200*40 8*1 1/2	219.1*48.3 8.625*1.9	2.07 300	75	155
200*50 8*2	219.1*60.3 8.625*2.375	2.07 300	85	150
200*65 8*2 1/2	219.1*73 8.625*2.875	2.07 300	90	155
200*65 8*2 1/2	219.1*76.1 8.625*3	2.07 300	95	150
200*80 8*3	219.1*88.9 8.625*3.5	2.07 300	100	155
200*100 8*4	219.1*114.3 8.625*4.5	2.07 300	110	155
250*50 10*2	273*60.3 10.75*2.375	2.07 300	90	197
250*65 10*2 1/2	273*73.0 10.75*2.875	2.07 300	90	197
250*65 10*2 1/2	273*76.1 10.75*3	2.07 300	90	197
250*80 10*3	273*88.9 10.75*3.5	2.07 300	100	197
250*100 10*4	273*114.3 10.75*4.5	2.07 300	125	210
300*100 12*4	323.9*114.3 12.75*4.5	2.07 300	125	220



XGQT05L

长沟槽异径三通

Long Radius
Grooved Reducing Tee

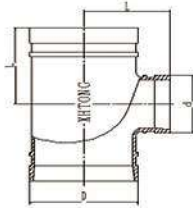

Nominal size	Pipe O.D mm/in	Working Pressure Mpa/psi	Dimension mm/in	Nominal size	Pipe O.D mm/in	Working Pressure Mpa/psi	Dimension mm/in
规格	钢管尺寸	工作压力	L	规格	钢管尺寸	工作压力	L
32*25 1½*1	42.4*33.7 1.66*1.327	2.07 300	70	100*80 4*3	108*88.9 4.252*3.5	2.07 300	102
40*25 1½*1	48.3*33.7 1.9*1.327	2.07 300	70	100*25 4*1	114.3*33.7 4.5*1.327	2.07 300	102
4*32 1½*1½	48.3*42.4 1.9*1.66	2.07 300	70	100*32 4*1¼	114.3*42.4 4.5*1.66	2.07 300	102
50*25 2*1	60.3*33.7 2.375*1.327	2.07 300	70	100*40 4*1½	114.3*48.3 4.5*1.9	2.07 300	102
50*32 2*1¼	60.3*42.4 2.375*1.66	2.07 300	70	100*50 4*2	114.3*60.3 4.5*2.375	2.07 300	102
60*40 2*1½	60.3*48.3 2.375*1.9	2.07 300	70	100*65 4*2½	114.3*73 4.5*2.875	2.07 300	102
65*25 2½*1	73*33.7 2.875*1.327	2.07 300	76	100*65 4*2½	114.3*76.1 4.5*3	2.07 300	102
65*32 2½*1¼	73*42.4 2.875*1.66	2.07 300	76	100*80 4*3	114.3*88.9 4.5*3.5	2.07 300	102
65*40 2½*1½	73*48.3 2.875*1.9	2.07 300	76	125*25 5*1	133*33.7 5.25*1.327	2.07 300	122
65*50 2½*2	73*60.3 2.875*2.375	2.07 300	76	125*32 5*1¼	133*42.4 5.25*1.66	2.07 300	122
65*25 2½*1	76.1*33.7 3*1.327	2.07 300	76	125*40 5*1½	133*48.3 5.25*1.9	2.07 300	122
65*32 2½*1¼	76.1*42.4 3*1.66	2.07 300	76	125*50 5*2	133*60.3 5.25*2.375	2.07 300	122
65*40 2½*1½	76.1*48.3 3*1.9	2.07 300	76	125*65 5*2½	133*73 5.25*2.875	2.07 300	122
65*50 2½*2	76.1*60.3 3*2.375	2.07 300	76	125*65 5*2½	133*76.1 5.25*3	2.07 300	122
80*25 3*1	88.9*33.7 3.5*1.327	2.07 300	86	125*80 5*3	133*88.9 5.25*3.5	2.07 300	122
80*32 3*1¼	88.9*42.4 3.5*1.66	2.07 300	86	125*100 5*4	133*114.3 5.25*4.5	2.07 300	122
80*40 3*1½	88.9*48.3 3.5*1.9	2.07 300	86	125*25 5*1	139.7*33.7 5.5*1.327	2.07 300	122
80*50 3*2	88.9*60.3 3.5*2.375	2.07 300	86	125*32 5*1¼	139.7*42.4 5.5*1.66	2.07 300	122
80*65 3*2½	88.9*73 3.5*2.875	2.07 300	86	125*40 5*1½	139.7*48.3 5.5*1.9	2.07 300	122
80*65 3*2½	88.9*76.1 3.5*3	2.07 300	86	125*50 5*2	139.7*60.3 5.5*2.375	2.07 300	122
100*25 4*1	108*33.7 4.252*1.327	2.07 300	102	125*65 5*2½	139.7*73 5.5*2.875	2.07 300	122
100*32 4*1¼	108*42.4 4.252*1.66	2.07 300	102	125*65 5*2½	139.7*76.1 5.5*3	2.07 300	122
100*40 4*1½	108*48.3 4.252*1.9	2.07 300	102	125*80 5*3	139.7*88.9 5.5*3.5	2.07 300	122
100*50 4*2	108*60.3 4.252*2.375	2.07 300	102	125*100 5*4	139.7*108 5.5*4.252	2.07 300	122
100*65 4*2½	108*73 4.252*2.875	2.07 300	102	125*100 5*4	139.7*114.3 5.5*4.5	2.07 300	122
100*65 4*2½	108*76.1 4.252*3	2.07 300	102	125*25 5*1	141.3*33.7 5.563*1.327	2.07 300	122



ISO9001:2008



ISO14001:2004



OHSAS18001:2007

PRODUCTS LIABILITY
INSURANCE POLICY SCHEDULE

XGQT05L

长沟槽异径三通

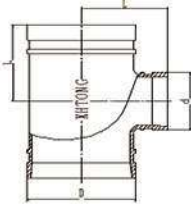
Long Radius
Grooved Reducing Tee

Nominal size	Pipe O.D mm/in	Working Pressure Mpa/psi	Dimension mm/in
规格	钢管尺寸	工作压力	L
125*32 5*1/4	141.3*42.4 5.563*1.66	2.07 300	122
125*40 5*1/2	141.3*48.3 5.563*1.9	2.07 300	122
125*50 5*2	141.3*60.3 5.563*2.375	2.07 300	122
125*65 5*2 1/2	141.3*73 5.563*2.875	2.07 300	122
125*65 5*2 1/2	141.3*76.1 5.563*3	2.07 300	122
125*80 5*3	141.3*88.9 5.563*3.5	2.07 300	122
125*100 5*4	141.3*108 5.563*4.252	2.07 300	122
125*100 5*4	141.3*114.3 5.563*4.5	2.07 300	122
150*25 6*1	159*33.7 6.25*1.327	2.07 300	140
150*32 6*1 1/4	159*42.4 6.25*1.66	2.07 300	140
150*40 6*1 1/2	159*48.3 6.25*1.9	2.07 300	140
150*50 6*2	159*60.3 6.25*2.375	2.07 300	140
150*65 6*2 1/2	159*73 6.25*2.875	2.07 300	140
150*65 6*2 1/2	159*76.1 6.25*3	2.07 300	140
150*80 6*3	159*88.9 6.25*3.5	2.07 300	140
150*100 6*4	159*108 6.25*4.252	2.07 300	140
150*100 6*4	159*114.3 6.25*4.5	2.07 300	140
150*125 6*5	159*139.7 6.25*5.5	2.07 300	140
150*125 6*5	159*141.3 6.25*5.563	2.07 300	140
150*25 6*1	165.1*33.7 6.5*1.327	2.07 300	140
150*32 6*1 1/4	165.1*42.4 6.5*1.66	2.07 300	140
150*40 6*1 1/2	165.1*48.3 6.5*1.9	2.07 300	140
150*50 6*2	165.1*60.3 6.5*2.375	2.07 300	140
150*65 6*2 1/2	165.1*73 6.5*2.875	2.07 300	140
150*65 6*2 1/2	165.1*76.1 6.5*3	2.07 300	140
150*80 6*3	165.1*88.9 6.5*3.5	2.07 300	140

Nominal size	Pipe O.D mm/in	Working Pressure Mpa/psi	Dimension mm/in
规格	钢管尺寸	工作压力	L
150*100 6*4	165.1*108 6.5*4.252	2.07 300	140
150*100 6*4	165.1*114.3 6.5*4.5	2.07 300	140
150*125 6*5	165.1*139.7 6.5*5.5	2.07 300	140
150*125 6*5	165.1*141.3 6.5*5.563	2.07 300	140
150*25 6*1	168.3*33.7 6.625*1.327	2.07 300	140
150*32 6*1 1/4	168.3*42.4 6.625*1.66	2.07 300	140
150*40 6*1 1/2	168.3*48.3 6.625*1.9	2.07 300	140
150*50 6*2	168.3*60.3 6.625*2.375	2.07 300	140
150*65 6*2 1/2	168.3*73 6.625*2.875	2.07 300	140
150*65 6*2 1/2	168.3*76.1 6.625*3	2.07 300	140
150*80 6*3	168.3*88.9 6.625*3.5	2.07 300	140
150*100 6*4	168.3*108 6.625*4.252	2.07 300	140
150*100 6*4	168.3*114.3 6.625*4.5	2.07 300	140
150*125 6*5	168.3*139.7 6.625*5.5	2.07 300	140
150*125 6*5	168.3*141.3 6.625*5.563	2.07 300	140
200*50 8*2	219.1*60.3 8.625*2.375	2.07 300	175
200*65 8*2 1/2	219.1*73 8.625*2.875	2.07 300	175
200*65 8*2 1/2	219.1*76.1 8.625*3	2.07 300	175
200*80 8*3	219.1*88.9 8.625*3.5	2.07 300	175
200*100 8*4	219.1*108 8.625*4.252	2.07 300	175
200*100 8*4	219.1*114.3 8.625*4.5	2.07 300	175
200*125 8*5	219.1*139.7 8.625*5.5	2.07 300	175
200*125 8*5	219.1*141.3 8.625*5.563	2.07 300	175
200*150 8*6	219.1*159 8.625*6.25	2.07 300	175
200*150 8*6	219.1*165.1 8.625*6.5	2.07 300	175
200*150 8*6	219.1*168.3 8.625*6.625	2.07 300	175

XGQT05L
长沟槽异径三通
Long Radius
Grooved Reducing Tee

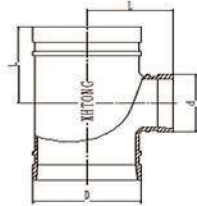

Nominal size	Pipe O.D mm/in	Working Pressure Mpa/psi	Dimension mm/in
规格	钢管尺寸	工作压力	L
250*100 10*4	273*108 10.75*4.252	2.07 300	229
250*100 10*4	273*114.3 10.75*4.5	2.07 300	229
250*125 10*5	273*139.7 10.75*5.5	2.07 300	229
250*125 10*5	273*141.3 10.75*5.563	2.07 300	229
250*150 10*6	273*159 10.75*6.25	2.07 300	229
250*150 10*6	273*165.1 10.75*6.5	2.07 300	229
250*150 10*6	273*168.3 10.75*6.625	2.07 300	229
250*200 10*8	273*219.1 10.75*8.625	2.07 300	229
300*100 12*4	323.9*114.3 12.75*4.5	2.07 300	254
300*125 12*5	323.9*139.7 12.75*5.5	2.07 300	254
300*125 12*5	323.9*141.3 112.75*5.563	2.07 300	254
300*150 12*6	323.9*159 12.75*6.25	2.07 300	254
300*150 12*6	323.9*165.1 12.75*6.5	2.07 300	254
300*150 12*6	323.9*168.3 12.75*6.625	2.07 300	254
300*200 12*8	323.9*219.1 12.75*8.625	2.07 300	254
300*250 12*10	323.9*273 12.75*10.75	2.07 300	254



PRODUCTS LIABILITY
INSURANCE POLICY SCHEDULE

XGQT05LS

长螺纹异径三通

Long Radius
Threaded Reducing Tee

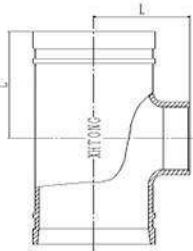

Nominal size	Pipe O.D mm/in	Working Pressure Mpa/psi	Dimension mm/in
规格	钢管尺寸	工作压力	L
32*25 1½*1	42.4*33.7 1.66*1.327	2.07 300	70
40*25 1½*1	48.3*33.7 1.9*1.327	2.07 300	70
40*32 1½*1½	48.3*42.4 1.9*1.66	2.07 300	70
50*25 2*1	60.3*33.7 2.375*1.327	2.07 300	70
50*32 2*1½	60.3*42.4 2.375*1.66	2.07 300	70
60*40 2*1½	60.3*48.3 2.375*1.9	2.07 300	70
65*25 2½*1	73*33.7 2.875*1.327	2.07 300	76
65*32 2½*1½	73*42.4 2.875*1.66	2.07 300	76
65*40 2½*1½	73*48.3 2.875*1.9	2.07 300	76
65*50 2½*2	73*60 2.875*2.375	2.07 300	76
65*25 2½*1	76.1*33.7 3*1.327	2.07 300	76
65*32 2½*1½	76.1*42.4 3*1.66	2.07 300	76
65*40 2½*1½	76.1*48.3 3*1.9	2.07 300	76
65*50 2½*2	76.1*60.3 3*2.375	2.07 300	76
80*25 3*1	88.9*33.7 3.5*1.327	2.07 300	86
80*32 3*1½	88.9*42.4 3.5*1.66	2.07 300	86
80*40 3*1½	88.9*48.3 3.5*1.9	2.07 300	86
80*50 3*2	88.9*60.3 3.5*2.375	2.07 300	86
80*65 3*2½	88.9*73 3.5*2.875	2.07 300	86
80*65 3*2½	88.9*76.1 3.5*3	2.07 300	86
100*25 4*1	108*33.7 4.252*1.327	2.07 300	102
100*32 4*1¼	108*42.4 4.252*1.66	2.07 300	102
100*40 4*1½	108*48.3 4.252*1.9	2.07 300	102
100*50 4*2	108*60.3 4.252*2.375	2.07 300	102
100*65 4*2½	108*73 4.252*2.875	2.07 300	102
100*65 4*2½	108*76.1 4.252*3	2.07 300	102

Nominal size	Pipe O.D mm/in	Working Pressure Mpa/psi	Dimension mm/in
规格	钢管尺寸	工作压力	L
100*80 4*3	108*88.9 4.252*3.5	2.07 300	102
100*25 4*1	114.3*33.7 4.5*1.327	2.07 300	102
100*32 4*1¼	114.3*42.4 4.5*1.66	2.07 300	102
100*40 4*1½	114.3*48.3 4.5*1.9	2.07 300	102
100*50 4*2	114.3*60.3 4.5*2.375	2.07 300	102
100*65 4*2½	114.3*73 4.5*2.875	2.07 300	102
100*65 4*2½	114.3*76.1 4.5*3	2.07 300	102
100*80 4*3	114.3*88.9 4.5*3.5	2.07 300	102
125*25 5*1	133*33.7 5.25*1.327	2.07 300	122
125*32 5*1¼	133*42.4 5.25*1.66	2.07 300	122
125*40 5*1½	133*48.3 5.25*1.9	2.07 300	122
125*50 5*2	133*60.3 5.25*2.375	2.07 300	122
125*65 5*2½	133*73 5.25*2.875	2.07 300	122
125*65 5*2½	133*76.1 5.25*3	2.07 300	122
125*80 5*3	133*88.9 5.25*3.5	2.07 300	122
125*100 5*4	133*114.3 5.25*4.5	2.07 300	122
125*25 5*1	139.7*33.7 5.5*1.327	2.07 300	122
125*32 5*1¼	139.7*42.4 5.5*1.66	2.07 300	122
125*40 5*1½	139.7*48.3 5.5*1.9	2.07 300	122
125*50 5*2	139.7*60.3 5.5*2.375	2.07 300	122
125*65 5*2½	139.7*73 5.5*2.875	2.07 300	122
125*65 5*2½	139.7*76.1 5.5*3	2.07 300	122
125*80 5*3	139.7*88.9 5.5*3.5	2.07 300	122
125*100 5*4	139.7*114.3 5.5*4.5	2.07 300	122
125*25 5*1	141.3*33.7 5.563*1.327	2.07 300	122
125*32 5*1¼	141.3*42.4 5.563*1.66	2.07 300	122



XGQT05LS

长螺纹异径三通

Long Radius
Threaded Reducing Tee

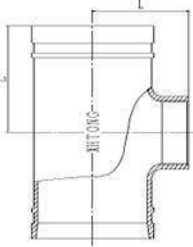

Nominal size	Pipe O.D mm/in	Working Pressure Mpa/psi	Dimension mm/in
规格	钢管尺寸	工作压力	L
125*40 5*1/2	141.3*48.3 5.563*1.9	2.07 300	122
125*50 5*2	141.3*60.3 5.563*2.375	2.07 300	122
125*65 5*2 1/2	141.3*73 5.563*2.875	2.07 300	122
125*65 5*2 1/2	141.3*76.1 5.563*3	2.07 300	122
125*80 5*3	141.3*88.9 5.563*3.5	2.07 300	122
125*100 5*4	141.3*114.3 5.563*4.5	2.07 300	122
150*25 6*1	159*33.7 6.25*1.327	2.07 300	140
150*32 6*1 1/4	159*42.4 6.25*1.66	2.07 300	140
150*40 6*1 1/2	159*48.3 6.25*1.9	2.07 300	140
150*50 6*2	159*60.3 6.25*2.375	2.07 300	140
150*65 6*2 1/2	159*73 6.25*2.875	2.07 300	140
150*65 6*2 1/2	159*76.1 6.25*3	2.07 300	140
150*80 6*3	159*88.9 6.25*3.5	2.07 300	140
150*100 6*4	159*114.3 6.25*4.5	2.07 300	140
150*25 6*1	165.1*33.7 6.5*1.327	2.07 300	140
150*32 6*1 1/4	165.1*42.4 6.5*1.66	2.07 300	140
150*40 6*1 1/2	165.1*48.3 6.5*1.9	2.07 300	140
150*50 6*2	165.1*60.3 6.5*2.375	2.07 300	140

Nominal size	Pipe O.D mm/in	Working Pressure Mpa/psi	Dimension mm/in
规格	钢管尺寸	工作压力	L
150*65 6*2 1/2	165.1*73 6.5*2.875	2.07 300	140
150*65 6*2 1/2	165.1*76.1 6.5*3	2.07 300	140
150*80 6*3	165.1*88.9 6.5*3.5	2.07 300	140
150*100 6*4	165.1*114.3 6.5*4.5	2.07 300	140
150*25 6*1	168.3*33.7 6.625*1.327	2.07 300	140
150*32 6*1 1/4	168.3*42.4 6.625*1.66	2.07 300	140
150*40 6*1 1/2	168.3*48.3 6.625*1.9	2.07 300	140
150*50 6*2	168.3*60.3 6.625*2.375	2.07 300	140
150*65 6*2 1/2	168.3*73 6.625*2.875	2.07 300	140
150*65 6*2 1/2	168.3*76.1 6.625*3	2.07 300	140
150*80 6*3	168.3*88.9 6.625*3.5	2.07 300	140
150*100 6*4	168.3*114.3 6.625*4.5	2.07 300	140
200*50 8*2	219.1*60.3 8.625*2.375	2.07 300	175
200*65 8*2 1/2	219.1*73 8.625*2.875	2.07 300	175
200*65 8*2 1/2	219.1*76.1 8.625*3	2.07 300	175
200*80 8*3	219.1*88.9 8.625*3.5	2.07 300	175
200*100 8*4	219.1*114.3 8.625*4.5	2.07 300	175
250*100 10*4	273*114.3 10.75*4.5	2.07 300	229
300*100 12*4	323.9*114.3 12.75*4.5	2.07 300	254



ISO9001:2008

ISO14001:2004

OHSAS18001:2007

PRODUCTS LIABILITY
INSURANCE POLICY SCHEDULE

XGQT05E
中大三通
Bullhead Tee



Nominal size 规格	Pipe O.D mm/in 钢管尺寸	Working Pressure Mpa/psi 工作压力	Dimension mm/in	
			L1	L2
50*50*65 2*2*2 ¹ / ₂	60.3*60.3*73 2.375*2.375*2.875	2.07 300	95	83
50*50*80 2*2*3	60.3*60.3*88.9 2.375*2.375*3.5	2.07 300	108	95
50*50*100 2*2*4	60.3*60.3*114.3 2.375*2.375*4.5	2.07 300	127	102
65*65*80 2 ¹ / ₂ *2 ¹ / ₂ *3	73*73*88.9 2.875*2.875*3.5	2.07 300	108	95
65*65*100 2 ¹ / ₂ *2 ¹ / ₂ *4	73*73*114.3 2.875*2.875*4.5	2.07 300	127	102
65*65*80 2 ¹ / ₂ *2 ¹ / ₂ *3	76.1*76.1*88.9 3*3*3.5	2.07 300	108	95
65*65*100 2 ¹ / ₂ *2 ¹ / ₂ *4	76.1*76.1*114.3 3*3*4.5	2.07 300	127	102
80*80*100 3*3*4	88.9*88.9*114.3 3.5*3.5*4.5	2.07 300	127	102
100*100*150 4*4*6	114.3*114.3*168.3 4.5*4.5*6.625	2.07 300	165	127
125*125*200 5*5*8	141.3*141.3*219.1 5.563*5.563*8.625	2.07 300	197	140
150*150*200 6*6*8	168.3*168.3*219.1 6.625*6.625*8.625	2.07 300	197	165

XGQT04

正四通

Equal Cross

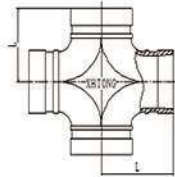

Nominal size 规格	Pipe O.D mm/in 钢管尺寸	Working Pressure Mpa/psi 工作压力	Dimension mm/in		
			L1		
25 1	33.7 1.315	2.07 300		57	57
32 1¼	42.4 1.66	2.07 300		60	70
40 1½	48.3 1.9	2.07 300		60	70
50 2	60.3 2.375	2.07 300	70	70	83
65 2½	73 2.875	2.07 300		76	95
65 2½	76.1 3	2.07 300	76	76	95
80 3	88.9 3.5	2.07 300	80	86	108
100 4	108 4.252	2.07 300	96	102	127
100 4	114.3 4.5	2.07 300	96	102	127
125 5	133 5.25	2.07 300	110	122	140
125 5	139.7 5.5	2.07 300	110	122	140
125 5	141.3 5.563	2.07 300		122	140
150 6	159 6.26	2.07 300	122	140	165
150 6	165.1 6.5	2.07 300	122	140	165
150 6	168.3 6.625	2.07 300	125	140	165
200 8	216.3 8.516	2.07 300		175	197
200 8	219.1 8.625	2.07 300	155	175	197
250 10	267.4 10.528	2.07 300		215	229
250 10	273 10.75	2.07 300	190	215	229
300 12	318.5 12.539	2.07 300		245	254
300 12	323.9 12.75	2.07 300	220	245	254
350 14	355.6 14.000	2.07 300			279
350 14	377.0 14.84	2.07 300			279
400 16	406.4 16.000	2.07 300			305
400 16	426.0 16.77	2.07 300			305
450 18	457.2 18.000	2.07 300			394
450 18	480.0 18.90	2.07 300			335
500 20	508.0 20.000	2.07 300			438
600 24	609.6 24.000	2.07 300			508



ISO9001:2008 ISO14001:2004 OHSAS18001:2007

PRODUCTS LIABILITY INSURANCE POLICY SCHEDULE

XGQT06

沟槽异径四通

Grooved Reducing Cross

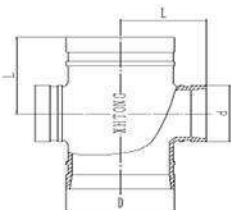

Nominal size	Pipe O.D mm/in	Working Pressure Mpa/psi	Dimension mm/in		Nominal size	Pipe O.D mm/in	Working Pressure Mpa/psi	Dimension mm/in	
			L1	L2				L1	L2
规格	钢管尺寸	工作压力	L1	L2	规格	钢管尺寸	工作压力	L1	L2
80*25 3*1	88.9*33.7 3.5*1.327	2.07 300	65	86	125*50 5*2	139.7*60.3 5.5*2.375	2.07 300	85	122
80*32 3*1/4	88.9*42.4 3.5*1.66	2.07 300	70	86	125*65 5*2 1/2	139.7*73 5.5*2.875	2.07 300	85	122
80*40 3*1/2	88.9*48.3 3.5*1.9	2.07 300	70	86	125*65 5*2 1/2	139.7*76.1 5.5*3	2.07 300	85	122
80*50 3*2	88.9*60.3 3.5*2.375	2.07 300	75	86	125*80 5*3	139.7*88.9 5.5*3.5	2.07 300	100	122
100*25 4*1	108*33.7 4.252*1.327	2.07 300	70	102	125*100 5*4	139.7*108 5.5*4.252	2.07 300	110	122
100*32 4*1 1/4	108*42.4 4.252*1.66	2.07 300	70	102	125*100 5*4	139.7*114.3 5.5*4.5	2.07 300	110	122
100*40 4*1 1/2	108*48.3 4.252*1.9	2.07 300	75	102	125*25 5*1	141.3*33.7 5.563*1.327	2.07 300	70	122
100*50 4*2	108*60.3 4.252*2.375	2.07 300	85	102	125*32 5*1 1/4	141.3*42.4 5.563*1.66	2.07 300	70	122
100*65 4*2 1/2	108*76.1 4.252*3	2.07 300	80	95	125*40 5*1 1/2	141.3*48.3 5.563*1.9	2.07 300	75	122
100*80 4*3	108*88.9 4.252*3.5	2.07 300	85	95	125*50 5*2	141.3*60.3 5.563*2.375	2.07 300	85	122
100*25 4*1	114.3*33.7 4.5*1.327	2.07 300	70	102	125*65 5*2 1/2	141.3*73 5.563*2.875	2.07 300	85	122
100*32 4*1 1/4	114.3*42.4 4.5*1.66	2.07 300	70	102	125*65 5*2 1/2	141.3*76.1 5.563*3	2.07 300	85	122
100*40 4*1 1/2	114.3*48.3 4.5*1.9	2.07 300	75	102	125*80 5*3	141.3*88.9 5.563*3.5	2.07 300	100	122
100*50 4*2	114.3*60.3 4.5*2.375	2.07 300	85	102	125*100 5*4	141.3*108 5.563*4.252	2.07 300	110	122
100*65 4*2 1/2	114.3*73 4.5*2.875	2.07 300	85	102	125*100 5*4	141.3*114.3 5.563*4.5	2.07 300	110	122
100*65 4*2 1/2	114.3*76.1 4.5*3	2.07 300	80	95	150*25 6*1	159*33.7 6.25*1.327	2.07 300	70	140
100*80 4*3	114.3*88.9 4.5*3.5	2.07 300	85	95	150*32 6*1 1/4	159*42.4 6.25*1.66	2.07 300	70	140
125*25 5*1	133*33.7 5.25*1.327	2.07 300	70	122	150*40 6*1 1/2	159*48.3 6.25*1.9	2.07 300	75	140
125*32 5*1 1/4	133*42.4 5.25*1.66	2.07 300	70	122	150*50 6*2	159*60.3 6.25*2.375	2.07 300	85	140
125*40 5*1 1/2	133*48.3 5.25*1.9	2.07 300	75	122	150*65 6*2 1/2	159*73 6.25*2.875	2.07 300	85	140
125*50 5*2	133*60.3 5.25*2.375	2.07 300	85	122	150*65 6*2 1/2	159*76.1 6.25*3	2.07 300	85	135
125*65 5*2 1/2	133*73 5.25*2.875	2.07 300	85	122	150*80 6*3	159*88.9 6.25*3.5	2.07 300	100	140
125*65 5*2 1/2	133*76.1 5.25*3	2.07 300	85	122	150*100 6*4	159*108 6.25*4.252	2.07 300	102	120
125*80 5*3	133*88.9 5.25*3.5	2.07 300	100	122	150*100 6*4	159*114.3 6.25*4.5	2.07 300	102	120
125*100 5*4	133*114.3 5.25*4.5	2.07 300	110	122	150*125 6*5	159*139.7 6.25*5.5	2.07 300	125	140
125*25 5*1	139.7*33.7 5.5*1.327	2.07 300	70	122	150*125 6*5	159*141.3 6.25*5.563	2.07 300	125	140
125*32 5*1 1/4	139.7*42.4 5.5*1.66	2.07 300	70	122	150*25 6*1	165.1*33.7 6.5*1.327	2.07 300	70	140
125*40 5*1 1/2	139.7*48.3 5.5*1.9	2.07 300	75	122	150*32 6*1 1/4	165.1*42.4 6.5*1.66	2.07 300	70	140

XGQT06

沟槽异径四通

Grooved Reducing Cross

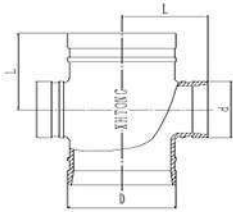

Nominal size	Pipe O.D mm/in	Working Pressure Mpa/psi	Dimension mm/in	
			L1	L2
规格	钢管尺寸	工作压力	L1	L2
150*40 6*1/2	165.1*48.3 6.5*1.9	2.07 300	75	140
150*50 6*2	165.1*60.3 6.5*2.375	2.07 300	85	140
150*65 6*2/2	165.1*73 6.5*2.875	2.07 300	85	140
150*65 6*2 1/2	165.1*76.1 6.5*3	2.07 300	85	135
150*80 6*3	165.1*88.9 6.5*3.5	2.07 300	100	140
150*100 6*4	165.1*108 6.5*4.252	2.07 300	102	120
150*100 6*4	165.1*114.3 6.5*4.5	2.07 300	102	120
150*125 6*5	165.1*139.7 6.5*5.5	2.07 300	125	140
150*125 6*5	165.1*141.3 6.5*5.563	2.07 300	125	140
150*25 6*1	168.3*33.7 6.625*1.327	2.07 300	70	140
150*32 6*1 1/4	168.3*42.4 6.625*1.66	2.07 300	70	140
150*40 6*1 1/2	168.3*48.3 6.625*1.9	2.07 300	75	140
150*50 6*2	168.3*60.3 6.625*2.375	2.07 300	85	140
150*65 6*2 1/2	168.3*73 6.625*2.875	2.07 300	85	140
150*65 6*2 1/2	168.3*76.1 6.625*3	2.07 300	85	135
150*80 6*3	168.3*88.9 6.625*3.5	2.07 300	100	140
150*100 6*4	168.3*108 6.625*4.252	2.07 300	102	120
150*100 6*4	168.3*114.3 6.625*4.5	2.07 300	102	120
150*125 6*5	168.3*139.7 6.625*5.5	2.07 300	125	140
150*125 6*5	168.3*141.3 6.625*5.563	2.07 300	125	140
200*32 8*1 1/4	219.1*42.4 8.625*1.66	2.07 300	75	155
200*40 8*1 1/2	219.1*48.3 8.625*1.9	2.07 300	75	155
200*50 8*2	219.1*60.3 8.625*2.375	2.07 300	90	155
200*65 8*2 1/2	219.1*73 8.625*2.875	2.07 300	90	155
200*65 8*2 1/2	219.1*76.1 8.625*3	2.07 300	90	160
200*80 8*3	219.1*88.9 8.625*3.5	2.07 300	100	165
200*100 8*4	219.1*108 8.625*4.252	2.07 300	110	170
200*100 8*4	219.1*114.3 8.625*4.5	2.07 300	110	170

Nominal size	Pipe O.D mm/in	Working Pressure Mpa/psi	Dimension mm/in	
			L1	L2
规格	钢管尺寸	工作压力	L1	L2
200*125 8*5	219.1*139.7 8.625*5.5	2.07 300	130	175
200*125 8*5	219.1*141.3 8.625*5.563	2.07 300	130	175
200*150 8*6	219.1*159 8.625*6.25	2.07 300	140	155
200*150 8*6	219.1*165.1 8.625*6.5	2.07 300	140	155
200*150 8*6	219.1*168.3 8.625*6.625	2.07 300	140	175
250*50 10*2	273*60.3 10.75*2.375	2.07 300	90	197
250*65 10*2 1/2	273*73.0 10.75*2.875	2.07 300	90	197
250*65 10*2 1/2	273*76.1 10.75*3	2.07 300	90	197
250*80 10*3	273*88.9 10.75*3.5	2.07 300	100	197
250*100 10*4	273*108 10.75*4.252	2.07 300	125	210
250*100 10*4	273*114.3 10.75*4.5	2.07 300	125	210
250*125 10*5	273*139.7 10.75*5.5	2.07 300	130	215
250*125 10*5	273*141.3 10.75*5.563	2.07 300	130	215
250*150 10*6	273*159 10.75*6.25	2.07 300	155	215
250*150 10*6	273*165.1 10.75*6.5	2.07 300	155	215
250*150 10*6	273*168.3 10.75*6.625	2.07 300	155	215
250*200 10*8	273*219.1 10.75*8.625	2.07 300	190	210
300*100 12*4	323.9*114.3 12.75*4.5	2.07 300	125	220
300*125 12*5	323.9*139.7 12.75*5.5	2.07 300	130	220
300*125 12*5	323.9*141.3 12.75*5.563	2.07 300	130	220
300*150 12*6	323.9*159 12.75*6.25	2.07 300	155	230
300*150 12*6	323.9*165.1 12.75*6.5	2.07 300	155	230
300*150 12*6	323.9*168.3 12.75*6.625	2.07 300	155	230
300*200 12*8	323.9*219.1 12.75*8.625	2.07 300	190	235
300*250 12*10	323.9*273 12.75*10.75	2.07 300	220	235



PRODUCTS LIABILITY
INSURANCE POLICY SCHEDULE

ISO9001:2008 ISO14001:2004 OHSAS18001:2007

XGQT06L

长沟槽异径四通

Long Radius
Grooved Reducing Cross

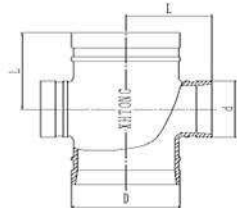

Nominal size	Pipe O.D mm/in	Working Pressure Mpa/psi	Dimension mm/in
规格	钢管尺寸	工作压力	L
32*25 1½*1	42.4*33.7 1.66*1.327	2.07 300	70
40*25 1½*1	48.3*33.7 1.9*1.327	2.07 300	70
4*32 1½*1¼	48.3*42.4 1.9*1.66	2.07 300	70
50*25 2*1	60.3*33.7 2.375*1.327	2.07 300	70
50*32 2*1¼	60.3*42.4 2.375*1.66	2.07 300	70
60*40 2*1½	60.3*48.3 2.375*1.9	2.07 300	70
65*25 2½*1	73*33.7 2.875*1.327	2.07 300	76
65*32 2½*1¼	73*42.4 2.875*1.66	2.07 300	76
65*40 2½*1½	73*48.3 2.875*1.9	2.07 300	76
65*50 2½*2	73*60.3 2.875*2.375	2.07 300	76
65*25 2½*1	76.1*33.7 3*1.327	2.07 300	76
65*32 2½*1¼	76.1*42.4 3*1.66	2.07 300	76
65*40 2½*1½	76.1*48.3 3*1.9	2.07 300	76
65*50 2½*2	76.1*60.3 3*2.375	2.07 300	76
80*25 3*1	88.9*33.7 3.5*1.327	2.07 300	86
80*32 3*1¼	88.9*42.4 3.5*1.66	2.07 300	86
80*40 3*1½	88.9*48.3 3.5*1.9	2.07 300	86
80*50 3*2	88.9*60.3 3.5*2.375	2.07 300	86
80*65 3*2½	88.9*73 3.5*2.875	2.07 300	86
80*65 3*2½	88.9*76.1 3.5*3	2.07 300	86
100*25 4*1	108*33.7 4.252*1.327	2.07 300	102
100*32 4*1¼	108*42.4 4.252*1.66	2.07 300	102
100*40 4*1½	108*48.3 4.252*1.9	2.07 300	102
100*50 4*2	108*60.3 4.252*2.375	2.07 300	102
100*65 4*2½	108*73 4.252*2.875	2.07 300	102
100*65 4*2½	108*76.1 4.252*3	2.07 300	102

Nominal size	Pipe O.D mm/in	Working Pressure Mpa/psi	Dimension mm/in
规格	钢管尺寸	工作压力	L
100*80 4*3	108*88.9 4.252*3.5	2.07 300	102
100*25 4*1	114.3*33.7 4.5*1.327	2.07 300	102
100*32 4*1¼	114.3*42.4 4.5*1.66	2.07 300	102
100*40 4*1½	114.3*48.3 4.5*1.9	2.07 300	102
100*50 4*2	114.3*60.3 4.5*2.375	2.07 300	102
100*65 4*2½	114.3*73 4.5*2.875	2.07 300	102
100*65 4*2½	114.3*76.1 4.5*3	2.07 300	102
100*80 4*3	114.3*88.9 4.5*3.5	2.07 300	102
125*25 5*1	133*33.7 5.25*1.327	2.07 300	122
125*32 5*1¼	133*42.4 5.25*1.66	2.07 300	122
125*40 5*1½	133*48.3 5.25*1.9	2.07 300	122
125*50 5*2	133*60.3 5.25*2.375	2.07 300	122
125*65 5*2½	133*73 5.25*2.875	2.07 300	122
125*65 5*2½	133*76.1 5.25*3	2.07 300	122
125*80 5*3	133*88.9 5.25*3.5	2.07 300	122
125*100 5*4	133*114.3 5.25*4.5	2.07 300	122
125*25 5*1	139.7*33.7 5.5*1.327	2.07 300	122
125*32 5*1¼	139.7*42.4 5.5*1.66	2.07 300	122
125*40 5*1½	139.7*48.3 5.5*1.9	2.07 300	122
125*50 5*2	139.7*60.3 5.5*2.375	2.07 300	122
125*65 5*2½	139.7*73 5.5*2.875	2.07 300	122
125*65 5*2½	139.7*76.1 5.5*3	2.07 300	122
125*80 5*3	139.7*88.9 5.5*3.5	2.07 300	122
125*100 5*4	139.7*108 5.5*4.252	2.07 300	122
125*100 5*4	139.7*114.3 5.5*4.5	2.07 300	122
125*25 5*1	141.3*33.7 5.563*1.327	2.07 300	122

XGQT06L

长沟槽异径四通

Long Radius
Grooved Reducing Cross

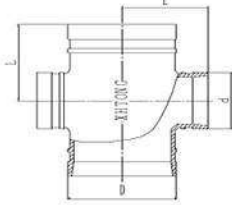

Nominal size	Pipe O.D mm/in	Working Pressure Mpa/psi	Dimension mm/in
规格	钢管尺寸	工作压力	L
125*32 5*1 ¹ / ₄	141.3*42.4 5.563*1.66	2.07 300	122
125*40 5*1 ¹ / ₂	141.3*48.3 5.563*1.9	2.07 300	122
125*50 5*2	141.3*60.3 5.563*2.375	2.07 300	122
125*65 5*2 ¹ / ₂	141.3*73 5.563*2.875	2.07 300	122
125*65 5*2 ¹ / ₂	141.3*76.1 5.563*3	2.07 300	122
125*80 5*3	141.3*88.9 5.563*3.5	2.07 300	122
125*100 5*4	141.3*108 5.563*4.252	2.07 300	122
125*100 5*4	141.3*114.3 5.563*4.5	2.07 300	122
150*25 6*1	159*33.7 6.25*1.327	2.07 300	140
150*32 6*1 ¹ / ₄	159*42.4 6.25*1.66	2.07 300	140
150*40 6*1 ¹ / ₂	159*48.3 6.25*1.9	2.07 300	140
150*50 6*2	159*60.3 6.25*2.375	2.07 300	140
150*65 6*2 ¹ / ₂	159*73 6.25*2.875	2.07 300	140
150*65 6*2 ¹ / ₂	159*76.1 6.25*3	2.07 300	140
150*80 6*3	159*88.9 6.25*3.5	2.07 300	140
150*100 6*4	159*108 6.25*4.252	2.07 300	140
150*100 6*4	159*114.3 6.25*4.5	2.07 300	140
150*125 6*5	159*139.7 6.25*5.5	2.07 300	140
150*125 6*5	159*141.3 6.25*5.563	2.07 300	140
150*25 6*1	165.1*33.7 6.5*1.327	2.07 300	140
150*32 6*1 ¹ / ₄	165.1*42.4 6.5*1.66	2.07 300	140
150*40 6*1 ¹ / ₂	165.1*48.3 6.5*1.9	2.07 300	140
150*50 6*2	165.1*60.3 6.5*2.375	2.07 300	140
150*65 6*2 ¹ / ₂	165.1*73 6.5*2.875	2.07 300	140
150*65 6*2 ¹ / ₂	165.1*76.1 6.5*3	2.07 300	140
150*80 6*3	165.1*88.9 6.5*3.5	2.07 300	140

Nominal size	Pipe O.D mm/in	Working Pressure Mpa/psi	Dimension mm/in
规格	钢管尺寸	工作压力	L
150*100 6*4	165.1*108 6.5*4.252	2.07 300	140
150*100 6*4	165.1*114.3 6.5*4.5	2.07 300	140
150*125 6*5	165.1*139.7 6.5*5.5	2.07 300	140
150*125 6*5	165.1*141.3 6.5*5.563	2.07 300	140
150*25 6*1	168.3*33.7 6.625*1.327	2.07 300	140
150*32 6*1 ¹ / ₄	168.3*42.4 6.625*1.66	2.07 300	140
150*40 6*1 ¹ / ₂	168.3*48.3 6.625*1.9	2.07 300	140
150*50 6*2	168.3*60.3 6.625*2.375	2.07 300	140
150*65 6*2 ¹ / ₂	168.3*73 6.625*2.875	2.07 300	140
150*65 6*2 ¹ / ₂	168.3*76.1 6.625*3	2.07 300	140
150*80 6*3	168.3*88.9 6.625*3.5	2.07 300	140
150*100 6*4	168.3*108 6.625*4.252	2.07 300	140
150*100 6*4	168.3*114.3 6.625*4.5	2.07 300	140
150*125 6*5	168.3*139.7 6.625*5.5	2.07 300	140
150*125 6*5	168.3*141.3 6.625*5.563	2.07 300	140
200*50 8*2	219.1*60.3 8.625*2.375	2.07 300	175
200*65 8*2 ¹ / ₂	219.1*73 8.625*2.875	2.07 300	175
200*65 8*2 ¹ / ₂	219.1*76.1 8.625*3	2.07 300	175
200*80 8*3	219.1*88.9 8.625*3.5	2.07 300	175
200*100 8*4	219.1*108 8.625*4.252	2.07 300	175
200*100 8*4	219.1*114.3 8.625*4.5	2.07 300	175
200*125 8*5	219.1*139.7 8.625*5.5	2.07 300	175
200*125 8*5	219.1*141.3 8.625*5.563	2.07 300	175
200*150 8*6	219.1*159 8.625*6.25	2.07 300	175
200*150 8*6	219.1*165.1 8.625*6.5	2.07 300	175
200*150 8*6	219.1*168.3 8.625*6.625	2.07 300	175



ISO9001:2008

ISO14001:2004

OHSAS18001:2007

PRODUCTS LIABILITY
INSURANCE POLICY SCHEDULE**XGQT06L**

长沟槽异径四通

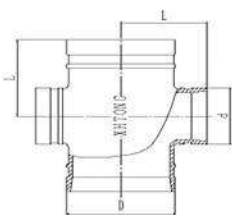
Long Radius
Grooved Reducing Cross

Nominal size	Pipe O.D mm/in	Working Pressure Mpa/psi	Dimension mm/in
规格	钢管尺寸	工作压力	L
250*100 10*4	273*108 10.75*4.252	2.07 300	229
250*100 10*4	273*114.3 10.75*4.5	2.07 300	229
250*125 10*5	273*139.7 10.75*5.5	2.07 300	229
250*125 10*5	273*141.3 10.75*5.563	2.07 300	229
250*150 10*6	273*159 10.75*6.25	2.07 300	229
250*150 10*6	273*165.1 10.75*6.5	2.07 300	229
250*150 10*6	273*168.3 10.75*6.625	2.07 300	229
250*200 10*8	273*219.1 10.75*8.625	2.07 300	229
300*100 12*4	323.9*114.3 12.75*4.5	2.07 300	254
300*125 12*5	323.9*139.7 12.75*5.5	2.07 300	254
300*125 12*5	323.9*141.3 112.75*5.563	2.07 300	254
300*150 12*6	323.9*159 12.75*6.25	2.07 300	254
300*150 12*6	323.9*165.1 12.75*6.5	2.07 300	254
300*150 12*6	323.9*168.3 12.75*6.625	2.07 300	254
300*200 12*8	323.9*219.1 12.75*8.625	2.07 300	254
300*250 12*10	323.9*273 12.75*10.75	2.07 300	254

XGQT06S

螺纹异径四通

Threaded Reducing Cross

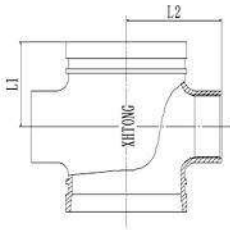

Nominal size	Pipe O.D mm/in	Working Pressure Mpa/psi	Dimension mm/in	
			L1	L2
80*25 3*1	88.9*33.7 3.5*1.327	2.07 300	65	86
80*32 3*1 1/4	88.9*42.4 3.5*1.66	2.07 300	70	86
80*40 3*1 1/2	88.9*48.3 3.5*1.9	2.07 300	70	86
80*50 3*2	88.9*60.3 3.5*2.375	2.07 300	75	86
100*25 4*1	108*33.7 4.252*1.327	2.07 300	70	102
100*32 4*1 1/4	108*42.4 4.252*1.66	2.07 300	70	102
100*40 4*1 1/2	108*48.3 4.252*1.9	2.07 300	75	102
100*50 4*2	108*60.3 4.252*2.375	2.07 300	85	102
100*65 4*2 1/2	108*76.1 4.252*3	2.07 300	80	95
100*80 4*3	108*88.9 4.252*3.5	2.07 300	85	95
100*25 4*1	114.3*33.7 4.5*1.327	2.07 300	70	102
100*32 4*1 1/4	114.3*42.4 4.5*1.66	2.07 300	70	102
100*40 4*1 1/2	114.3*48.3 4.5*1.9	2.07 300	75	102
100*50 4*2	114.3*60.3 4.5*2.375	2.07 300	85	102
100*65 4*2 1/2	114.3*73 4.5*2.875	2.07 300	85	102
100*65 4*2 1/2	114.3*76.1 4.5*3	2.07 300	80	95
100*80 4*3	114.3*88.9 4.5*3.5	2.07 300	85	95
125*25 5*1	133*33.7 5.25*1.327	2.07 300	70	122
125*32 5*1 1/4	133*42.4 5.25*1.66	2.07 300	70	122
125*40 5*1 1/2	133*48.3 5.25*1.9	2.07 300	75	122
125*50 5*2	133*60.3 5.25*2.375	2.07 300	85	122
125*65 5*2 1/2	133*73 5.25*2.875	2.07 300	85	122
125*65 5*2 1/2	133*76.1 5.25*3	2.07 300	85	122
125*80 5*3	133*88.9 5.25*3.5	2.07 300	100	122
125*100 5*4	133*114.3 5.25*4.5	2.07 300	110	122
125*25 5*1	139.7*33.7 5.5*1.327	2.07 300	70	122
125*32 5*1 1/4	139.7*42.4 5.5*1.66	2.07 300	70	122
125*40 5*1 1/2	139.7*48.3 5.5*1.9	2.07 300	75	122
125*50 5*2	139.7*60.3 5.5*2.375	2.07 300	85	122
125*65 5*2 1/2	139.7*73 5.5*2.875	2.07 300	85	122

Nominal size	Pipe O.D mm/in	Working Pressure Mpa/psi	Dimension mm/in	
			L1	L2
125*65 5*2 1/2	139.7*76.1 5.5*3	2.07 300	85	122
125*80 5*3	139.7*88.9 5.5*3.5	2.07 300	100	122
125*100 5*4	139.7*114.3 5.5*4.5	2.07 300	110	122
125*25 5*1	141.3*33.7 5.563*1.327	2.07 300	70	122
125*32 5*1 1/4	141.3*42.4 5.563*1.66	2.07 300	70	122
125*40 5*1 1/2	141.3*48.3 5.563*1.9	2.07 300	75	122
125*50 5*2	141.3*60.3 5.563*2.375	2.07 300	85	122
125*65 5*2 1/2	141.3*73 5.563*2.875	2.07 300	85	122
125*65 5*2 1/2	141.3*76.1 5.563*3	2.07 300	85	122
125*80 5*3	141.3*88.9 5.563*3.5	2.07 300	100	122
125*100 5*4	141.3*114.3 5.563*4.5	2.07 300	110	122
150*25 6*1	159*33.7 6.25*1.327	2.07 300	70	140
150*32 6*1 1/4	159*42.4 6.25*1.66	2.07 300	70	140
150*40 6*1 1/2	159*48.3 6.25*1.9	2.07 300	75	140
150*50 6*2	159*60.3 6.25*2.375	2.07 300	85	140
150*65 6*2 1/2	159*73 6.25*2.875	2.07 300	85	140
150*65 6*2 1/2	159*76.1 6.25*3	2.07 300	85	135
150*80 6*3	159*88.9 6.25*3.5	2.07 300	100	140
150*100 6*4	159*114.3 6.25*4.5	2.07 300	102	120
150*25 6*1	165.1*33.7 6.5*1.327	2.07 300	70	140
150*32 6*1 1/4	165.1*42.4 6.5*1.66	2.07 300	70	140
150*40 6*1 1/2	165.1*48.3 6.5*1.9	2.07 300	75	140
150*50 6*2	165.1*60.3 6.5*2.375	2.07 300	85	140
150*65 6*2 1/2	165.1*73 6.5*2.875	2.07 300	85	140
150*65 6*2 1/2	165.1*76.1 6.5*3	2.07 300	85	135
150*80 6*3	165.1*88.9 6.5*3.5	2.07 300	100	140
150*100 6*4	165.1*114.3 6.5*4.5	2.07 300	102	120
150*25 6*1	168.3*33.7 6.625*1.327	2.07 300	70	140
150*32 6*1 1/4	168.3*42.4 6.625*1.66	2.07 300	70	140
150*40 6*1 1/2	168.3*48.3 6.625*1.9	2.07 300	75	140



ISO9001:2008

ISO14001:2004

OHSAS18001:2007

PRODUCTS LIABILITY
INSURANCE POLICY SCHEDULE

XGQT06S

螺纹异径四通

Threaded Reducing Cross

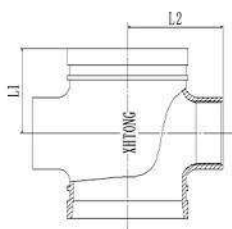

Nominal size	Pipe O.D mm/in	Working Pressure Mpa/psi	Dimension mm/in	
			L1	L2
规格	钢管尺寸	工作压力	L1	L2
150*50 6*2	168.3*60.3 6.625*2.375	2.07 300	85	140
150*65 6*2½	168.3*73 6.625*2.875	2.07 300	85	140
150*65 6*2½	168.3*76.1 6.625*3	2.07 300	85	135
150*80 6*3	168.3*88.9 6.625*3.5	2.07 300	100	140
150*100 6*4	168.3*114.3 6.625*4.5	2.07 300	102	120
200*32 8*1¼	219.1*42.4 8.625*1.66	2.07 300	75	155
200*40 8*1½	219.1*48.3 8.625*1.9	2.07 300	75	155
200*50 8*2	219.1*60.3 8.625*2.375	2.07 300	90	155
200*65 8*2½	219.1*73 8.625*2.875	2.07 300	90	155
200*65 8*2½	219.1*76.1 8.625*3	2.07 300	90	160
200*80 8*3	219.1*88.9 8.625*3.5	2.07 300	100	165
200*100 8*4	219.1*114.3 8.625*4.5	2.07 300	110	170
250*50 10*2	273*60.3 10.75*2.375	2.07 300	90	197
250*65 10*2½	273*73.0 10.75*2.875	2.07 300	90	197
250*65 10*2½	273*76.1 10.75*3	2.07 300	90	197
250*80 10*3	273*88.9 10.75*3.5	2.07 300	100	197
250*100 10*4	273*114.3 10.75*4.5	2.07 300	125	210
300*100 12*4	323.9*114.3 12.75*4.5	2.07 300	125	220

XGQT06LS

长螺纹异径四通

Long Radius

Threaded Reducing Cross

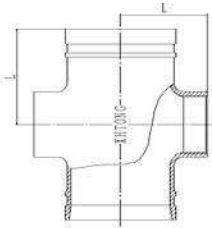

Nominal size	Pipe O.D mm/in	Working Pressure Mpa/psi	Dimension mm/in
规格	钢管尺寸	工作压力	L
32*25 1½*1	42.4*33.7 1.66*1.327	2.07 300	70
40*25 1½*1	48.3*33.7 1.9*1.327	2.07 300	70
4*32 1½*1¼	48.3*42.4 1.9*1.66	2.07 300	70
50*25 2*1	60.3*33.7 2.375*1.327	2.07 300	70
50*32 2*1¼	60.3*42.4 2.375*1.66	2.07 300	70
60*40 2*1¼	60.3*48.3 2.375*1.9	2.07 300	70
65*25 2½*1	73*33.7 2.875*1.327	2.07 300	76
65*32 2½*1¼	73*42.4 2.875*1.66	2.07 300	76
65*40 2½*1½	73*48.3 2.875*1.9	2.07 300	76
65*50 2½*2	73*60.3 2.875*2.375	2.07 300	76
65*25 2½*1	76.1*33.7 3*1.327	2.07 300	76
65*32 2½*1¼	76.1*42.4 3*1.66	2.07 300	76
65*40 2½*1½	76.1*48.3 3*1.9	2.07 300	76
65*50 2½*2	76.1*60.3 3*2.375	2.07 300	76
80*25 3*1	88.9*33.7 3.5*1.327	2.07 300	86
80*32 3*1¼	88.9*42.4 3.5*1.66	2.07 300	86
80*40 3*1½	88.9*48.3 3.5*1.9	2.07 300	86
80*50 3*2	88.9*60.3 3.5*2.375	2.07 300	86
80*65 3*2½	88.9*73 3.5*2.875	2.07 300	86
80*65 3*2½	88.9*76.1 3.5*3	2.07 300	86
100*25 4*1	108*33.7 4.252*1.327	2.07 300	102
100*32 4*1¼	108*42.4 4.252*1.66	2.07 300	102
100*40 4*1½	108*48.3 4.252*1.9	2.07 300	102

Nominal size	Pipe O.D mm/in	Working Pressure Mpa/psi	Dimension mm/in
规格	钢管尺寸	工作压力	L
100*50 4*2	108*60.3 4.252*2.375	2.07 300	102
100*65 4*2 ½	108*73 4.252*2.875	2.07 300	102
100*65 4*2 ½	108*76.1 4.252*3	2.07 300	102
100*80 4*3	108*88.9 4.252*3.5	2.07 300	102
100*25 4*1	114.3*33.7 4.5*1.327	2.07 300	102
100*32 4*1¼	114.3*42.4 4.5*1.66	2.07 300	102
100*40 4*1½	114.3*48.3 4.5*1.9	2.07 300	102
100*50 4*2	114.3*60.3 4.5*2.375	2.07 300	102
100*65 4*2 ½	114.3*73 4.5*2.875	2.07 300	102
100*65 4*2½	114.3*76.1 4.5*3	2.07 300	102
100*80 4*3	114.3*88.9 4.5*3.5	2.07 300	102
125*25 5*1	133*33.7 5.25*1.327	2.07 300	122
125*32 5*1¼	133*42.4 5.25*1.66	2.07 300	122
125*40 5*1½	133*48.3 5.25*1.9	2.07 300	122
125*50 5*2	133*60.3 5.25*2.375	2.07 300	122
125*65 5*2½	133*73 5.25*2.875	2.07 300	122
125*65 5*2½	133*76.1 5.25*3	2.07 300	122
125*80 5*3	133*88.9 5.25*3.5	2.07 300	122
125*100 5*4	133*114.3 5.25*4.5	2.07 300	122
125*25 5*1	139.7*33.7 5.5*1.327	2.07 300	122
125*32 5*1¼	139.7*42.4 5.5*1.66	2.07 300	122
125*40 5*1½	139.7*48.3 5.5*1.9	2.07 300	122
125*50 5*2	139.7*60.3 5.5*2.375	2.07 300	122



ISO9001:2008 ISO14001:2004 OHSAS18001:2007

PRODUCTS LIABILITY
INSURANCE POLICY'S SCHEDULE

XGQT06LS

长螺纹异径四通

Long Radius

Threaded Reducing Cross

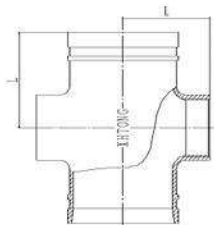

Nominal size	Pipe O.D mm/in	Working Pressure Mpa/psi	Dimension mm/in
规格	钢管尺寸	工作压力	L
125*65 5*2 ¹ / ₂	139.7*73 5.5*2.875	2.07 300	122
125*65 5*2 ¹ / ₂	139.7*76.1 5.5*3	2.07 300	122
125*80 5*3	139.7*88.9 5.5*3.5	2.07 300	122
125*100 5*4	139.7*114.3 5.5*4.5	2.07 300	122
125*25 5*1	141.3*33.7 5.563*1.327	2.07 300	122
125*32 5*1 ¹ / ₄	141.3*42.4 5.563*1.66	2.07 300	122
125*40 5*1 ¹ / ₂	141.3*48.3 5.563*1.9	2.07 300	122
125*50 5*2	141.3*60.3 5.563*2.375	2.07 300	122
125*65 5*2 ¹ / ₂	141.3*73 5.563*2.875	2.07 300	122
125*65 5*2 ¹ / ₂	141.3*76.1 5.563*3	2.07 300	122
125*80 5*3	141.3*88.9 5.563*3.5	2.07 300	122
125*100 5*4	141.3*114.3 5.563*4.5	2.07 300	122
150*25 6*1	159*33.7 6.25*1.327	2.07 300	140
150*32 6*1 ¹ / ₄	159*42.4 6.25*1.66	2.07 300	140
150*40 6*1 ¹ / ₂	159*48.3 6.25*1.9	2.07 300	140
150*50 6*2	159*60.3 6.25*2.375	2.07 300	140
150*65 6*2 ¹ / ₂	159*73 6.25*2.875	2.07 300	140
150*65 6*2 ¹ / ₂	159*76.1 6.25*3	2.07 300	140
150*80 6*3	159*88.9 6.25*3.5	2.07 300	140
150*100 6*4	159*114.3 6.25*4.5	2.07 300	140
150*25 6*1	165.1*33.7 6.5*1.327	2.07 300	140
150*32 6*1 ¹ / ₄	165.1*42.4 6.5*1.66	2.07 300	140
150*40 6*1 ¹ / ₂	165.1*48.3 6.5*1.9	2.07 300	140

Nominal size	Pipe O.D mm/in	Working Pressure Mpa/psi	Dimension mm/in
规格	钢管尺寸	工作压力	L
150*50 6*2	165.1*60.3 6.5*2.375	2.07 300	140
150*65 6*2 ¹ / ₂	165.1*73 6.5*2.875	2.07 300	140
150*65 6*2 ¹ / ₂	165.1*76.1 6.5*3	2.07 300	140
150*80 6*3	165.1*88.9 6.5*3.5	2.07 300	140
150*100 6*4	165.1*114.3 6.5*4.5	2.07 300	140
150*25 6*1	168.3*33.7 6.625*1.327	2.07 300	140
150*32 6*1 ¹ / ₄	168.3*42.4 6.625*1.66	2.07 300	140
150*40 6*1 ¹ / ₂	168.3*48.3 6.625*1.9	2.07 300	140
150*50 6*2	168.3*60.3 6.625*2.375	2.07 300	140
150*65 6*2 ¹ / ₂	168.3*73 6.625*2.875	2.07 300	140
150*65 6*2 ¹ / ₂	168.3*76.1 6.625*3	2.07 300	140
150*80 6*3	168.3*88.9 6.625*3.5	2.07 300	140
150*100 6*4	168.3*114.3 6.625*4.5	2.07 300	140
200*50 8*2	219.1*60.3 8.625*2.375	2.07 300	175
200*65 8*2 ¹ / ₂	219.1*73 8.625*2.875	2.07 300	175
200*65 8*2 ¹ / ₂	219.1*76.1 8.625*3	2.07 300	175
200*80 8*3	219.1*88.9 8.625*3.5	2.07 300	175
200*100 8*4	219.1*114.3 8.625*4.5	2.07 300	175
250*100 10*4	273*114.3 10.75*4.5	2.07 300	229
300*100 12*4	323.9*114.3 12.75*4.5	2.07 300	254

XGQT07
沟槽同心异径管
Grooved Concentric Reducer

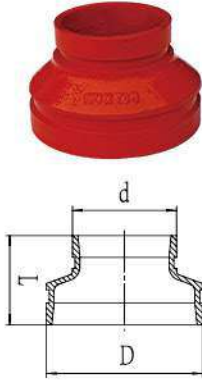

Nominal size	Pipe O.D mm/in	Working Pressure Mpa/psi	Dimension mm/in	
规格	钢管尺寸	工作压力	L	
32*25 1 1/2*1	42.4*33.7 1.66*1.327	2.07 300	64	
40*25 1 1/2*1	48.3*33.7 1.9*1.327	2.07 300	64	
4*32 1 1/2*1 1/4	48.3*42.4 1.9*1.66	2.07 300	64	
50*15 2*1/2	60.3*21.3 2.375*0.825	2.07 300	55	
50*20 2*1/4	60.3*26.9 2.375*1.05	2.07 300	55	
50*25 2*1	60.3*33.7 2.375*1.327	2.07 300	58	64
50*32 2*1 1/4	60.3*42.4 2.375*1.66	2.07 300	58	64
60*40 2*1 1/2	60.3*48.3 2.375*1.9	2.07 300	58	64
65*25 2 1/2*1	73*33.7 2.875*1.327	2.07 300	60	64
65*32 2 1/2*1 1/4	73*42.4 2.875*1.66	2.07 300	60	64
65*40 2 1/2*1 1/2	73*48.3 2.875*1.9	2.07 300	60	64
65*50 2 1/2*2	73*60.3 2.875*2.375	2.07 300	55	64
65*15 2 1/2*1/2	76.1*21.3 3*0.825	2.07 300	55	64
65*20 2 1/2*3/4	76.1*26.9 3*1.05	2.07 300	55	64
65*25 2 1/2*1	76.1*33.7 3*1.327	2.07 300	60	64
65*32 2 1/2*1 1/4	76.1*42.4 3*1.66	2.07 300	60	64
65*40 2 1/2*1 1/2	76.1*48.3 3*1.9	2.07 300	60	64
65*50 2 1/2*2	76.1*60.3 3*2.375	2.07 300	58	64
80*15 3*1/2	88.9*21.3 3.5*0.825	2.07 300	60	64
80*20 3*3/4	88.9*26.9 3.5*1.05	2.07 300	60	64
80*25 3*1	88.9*33.7 3.5*1.327	2.07 300	60	64
80*32 3*1 1/4	88.9*42.4 3.5*1.66	2.07 300	60	64
80*40 3*1 1/2	88.9*48.3 3.5*1.9	2.07 300	60	64
80*50 3*2	88.9*60.3 3.5*2.375	2.07 300	60	64
80*65 3*2 1/2	88.9*73 3.5*2.875	2.07 300	60	64
80*65 3*2 1/2	88.9*76.1 3.5*3	2.07 300	60	64
100*25 4*1	108*33.7 4.252*1.327	2.07 300	65	76
100*32 4*1 1/4	108*42.4 4.252*1.66	2.07 300	65	76
100*40 4*1 1/2	108*48.3 4.252*1.9	2.07 300	65	76
100*50 4*2	108*60.3 4.252*2.375	2.07 300	65	76
100*65 4*2 1/2	108*73 4.252*2.875	2.07 300	65	76
100*65 4*2 1/2	108*76.1 4.252*3	2.07 300	65	76

Nominal size	Pipe O.D mm/in	Working Pressure Mpa/psi	Dimension mm/in	
规格	钢管尺寸	工作压力	L	
100*80 4*3	108*88.9 4.252*3.5	2.07 300	65	76
100*25 4*1	114.3*33.7 4.5*1.327	2.07 300	65	76
100*32 4*1 1/4	114.3*42.4 4.5*1.66	2.07 300	65	76
100*40 4*1 1/2	114.3*48.3 4.5*1.9	2.07 300	65	76
100*50 4*2	114.3*60.3 4.5*2.375	2.07 300	65	76
100*65 4*2 1/2	114.3*73 4.5*2.875	2.07 300	65	76
100*65 4*2 1/2	114.3*76.1 4.5*3	2.07 300	65	76
100*80 4*3	114.3*88.9 4.5*3.5	2.07 300	65	76
125*25 5*1	133*33.7 5.25*1.327	2.07 300	70	89
125*32 5*1 1/4	133*42.4 5.25*1.66	2.07 300	70	89
125*40 5*1 1/2	133*48.3 5.25*1.9	2.07 300	70	89
125*50 5*2	133*60.3 5.25*2.375	2.07 300	70	89
125*65 5*2 1/2	133*73 5.25*2.875	2.07 300	70	89
125*65 5*2 1/2	133*76.1 5.25*3	2.07 300	70	89
125*80 5*3	133*88.9 5.25*3.5	2.07 300	70	89
125*100 5*4	133*114.3 5.25*4.5	2.07 300	65	89
125*25 5*1	139.7*33.7 5.5*1.327	2.07 300	70	89
125*32 5*1 1/4	139.7*42.4 5.5*1.66	2.07 300	70	89
125*40 5*1 1/2	139.7*48.3 5.5*1.9	2.07 300	70	89
125*50 5*2	139.7*60.3 5.5*2.375	2.07 300	70	89
125*65 5*2 1/2	139.7*73 5.5*2.875	2.07 300	70	89
125*65 5*2 1/2	139.7*76.1 5.5*3	2.07 300	70	89
125*80 5*3	139.7*88.9 5.5*3.5	2.07 300	70	89
125*100 5*4	139.7*108 5.5*4.252	2.07 300	70	89
125*100 5*4	139.7*114.3 5.5*4.5	2.07 300	70	89
125*25 5*1	141.3*33.7 5.563*1.327	2.07 300	70	89
125*32 5*1 1/4	141.3*42.4 5.563*1.66	2.07 300	70	89
125*40 5*1 1/2	141.3*48.3 5.563*1.9	2.07 300	70	89
125*50 5*2	141.3*60.3 5.563*2.375	2.07 300	70	89
125*65 5*2 1/2	141.3*73 5.563*2.875	2.07 300	70	89
125*65 5*2 1/2	141.3*76.1 5.563*3	2.07 300	70	89
125*80 5*3	141.3*88.9 5.563*3.5	2.07 300	70	89



ISO9001:2008

ISO14001:2004

OHSAS18001:2007

PRODUCTS LIABILITY
INSURANCE POLICY SCHEDULE

XGQT07

沟槽同心异径管

Grooved Concentric Reducer

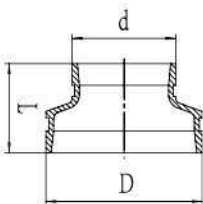

Nominal size	Pipe O.D mm/in	Working Pressure Mpa/psi	Dimension mm/in	
			L	
规格	钢管尺寸	工作压力	L	
125*100 5*4	141.3*108 5.563*4.252	2.07 300	70	89
125*100 5*4	141.3*114.3 5.563*4.5	2.07 300	70	89
150*25 6*1	159*33.7 6.25*1.327	2.07 300	75	102
150*32 6*1 1/4	159*42.4 6.25*1.66	2.07 300	75	102
150*40 6*1 1/2	159*48.3 6.25*1.9	2.07 300	75	102
150*50 6*2	159*60.3 6.25*2.375	2.07 300	75	102
150*65 6*2 1/2	159*73 6.25*2.875	2.07 300	75	102
150*65 6*2 1/2	159*76.1 6.25*3	2.07 300	75	102
150*80 6*3	159*88.9 6.25*3.5	2.07 300	75	102
150*100 6*4	159*108 6.25*4.252	2.07 300	75	102
150*100 6*4	159*114.3 6.25*4.5	2.07 300	75	102
150*125 6*5	159*139.7 6.25*5.5	2.07 300	75	102
150*125 6*5	159*141.3 6.25*5.563	2.07 300	75	102
150*25 6*1	165.1*33.7 6.5*1.327	2.07 300	75	102
150*32 6*1 1/4	165.1*42.4 6.5*1.66	2.07 300	75	102
150*40 6*1 1/2	165.1*48.3 6.5*1.9	2.07 300	75	102
150*50 6*2	165.1*60.3 6.5*2.375	2.07 300	75	102
150*65 6*2 1/2	165.1*73 6.5*2.875	2.07 300	75	102
150*65 6*2 1/2	165.1*76.1 6.5*3	2.07 300	75	102
150*80 6*3	165.1*88.9 6.5*3.5	2.07 300	75	102
150*100 6*4	165.1*108 6.5*4.252	2.07 300	75	102
150*100 6*4	165.1*114.3 6.5*4.5	2.07 300	75	102
150*125 6*5	165.1*139.7 6.5*5.5	2.07 300	65	102
150*125 6*5	165.1*141.3 6.5*5.563	2.07 300	65	102
150*25 6*1	168.3*33.7 6.625*1.327	2.07 300	75	102
150*32 6*1 1/4	168.3*42.4 6.625*1.66	2.07 300	75	102
150*40 6*1 1/2	168.3*48.3 6.625*1.9	2.07 300	75	102
150*50 6*2	168.3*60.3 6.625*2.375	2.07 300	75	102
150*65 6*2 1/2	168.3*73 6.625*2.875	2.07 300	75	102
150*65 6*2 1/2	168.3*76.1 6.625*3	2.07 300	75	102
150*80 6*3	168.3*88.9 6.625*3.5	2.07 300	75	102
150*100 6*4	168.3*108 6.625*4.252	2.07 300	75	102

Nominal size	Pipe O.D mm/in	Working Pressure Mpa/psi	Dimension mm/in	
			L	
规格	钢管尺寸	工作压力	L	
150*100 6*4	168.3*114.3 6.625*4.5	2.07 300	75	102
150*125 6*5	168.3*139.7 6.625*5.5	2.07 300	65	102
150*125 6*5	168.3*141.3 6.625*5.563	2.07 300	65	102
200*100 8*4	216.3*114.3 8.516*4.5	2.07 300	85	127
200*125 8*5	216.3*139.7 8.516*5.5	2.07 300	85	127
200*150 8*6	216.3*165.1 8.516*6.5	2.07 300	85	127
200*50 8*2	219.1*60.3 8.625*2.375	2.07 300	85	127
200*65 8*2 1/2	219.1*73 8.625*2.875	2.07 300	85	127
200*65 8*2 1/2	219.1*76.1 8.625*3	2.07 300	85	127
200*80 8*3	219.1*88.9 8.625*3.5	2.07 300	85	127
200*100 8*4	219.1*108 8.625*4.252	2.07 300	85	127
200*100 8*4	219.1*114.3 8.625*4.5	2.07 300	85	127
200*125 8*5	219.1*139.7 8.625*5.5	2.07 300	85	127
200*125 8*5	219.1*141.3 8.625*5.563	2.07 300	85	127
200*150 8*6	219.1*159 8.625*6.25	2.07 300	80	127
200*150 8*6	219.1*165.1 8.625*6.5	2.07 300	80	127
200*150 8*6	219.1*168.3 8.625*6.625	2.07 300	80	127
250*100 10*4	273*108 10.75*4.252	2.07 300	90	152
250*100 10*4	273*114.3 10.75*4.5	2.07 300	90	152
250*125 10*5	273*139.7 10.75*5.5	2.07 300	90	152
250*125 10*5	273*141.3 10.75*5.563	2.07 300	90	152
250*150 10*6	273*159 10.75*6.25	2.07 300	90	152
250*150 10*6	273*165.1 10.75*6.5	2.07 300	90	152
250*150 10*6	273*168.3 10.75*6.625	2.07 300	90	152
250*200 10*8	273*219.1 10.75*8.625	2.07 300	85	152
300*100 12*4	323.9*114.3 12.75*4.5	2.07 300	90	178
300*125 12*5	323.9*139.7 12.75*5.5	2.07 300	90	178
300*125 12*5	323.9*141.3 12.75*5.563	2.07 300	90	178
300*150 12*6	323.9*159 12.75*6.25	2.07 300	90	178
300*150 12*6	323.9*165.1 12.75*6.5	2.07 300	90	178
300*150 12*6	323.9*168.3 12.75*6.625	2.07 300	90	178
300*200 12*8	323.9*219.1 12.75*8.625	2.07 300	90	178
300*250 12*10	323.9*273 12.75*10.75	2.07 300	90	178

XGQT07S

螺纹同心异径管

Threaded Concentric Reducer

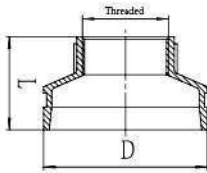

BSPT and NPT threads are also available, please specify when order.

Nominal size	Pipe O.D mm/in	Working Pressure Mpa/psi	Dimension mm/in	
规格	钢管尺寸	工作压力	L	
32*25 1 1/4*1	42.4*33.7 1.66*1.327	2.07 300	64	
40*25 1 1/2*1	48.3*33.7 1.9*1.327	2.07 300	64	
4*32 1 1/2*1 1/4	48.3*42.7 1.9*1.66	2.07 300	64	
50*15 2*1/2	60.3*21.3 2.375*0.825	2.07 300	55	
50*20 2*3/4	60.3*26.9 2.375*1.05	2.07 300	55	
50*25 2*1	60.3*33.7 2.375*1.327	2.07 300	58	64
50*32 2*1 1/4	60.3*42.4 2.375*1.66	2.07 300	58	64
60*40 2*1 1/2	60.3*48.3 2.375*1.9	2.07 300	58	64
65*15 2 1/2*1 1/2	73*21.3 2.875*0.825	2.07 300	55	64
65*20 2 1/2*3/4	73*26.9 2.875*1.05	2.07 300	55	64
65*25 2 3/4*1	73*33.7 2.875*1.327	2.07 300	60	64
65*32 2 3/4*1 1/4	73*42.4 2.875*1.66	2.07 300	60	64
65*40 2 3/4*1 1/2	73*48.3 2.875*1.9	2.07 300	60	64
65*50 2 3/4*2	73*60.3 2.875*2.375	2.07 300	55	64
65*15 2 1/2*1 1/2	76.1*21.3 3*0.825	2.07 300	55	64
65*20 2 1/2*3/4	76.1*26.9 3*1.05	2.07 300	55	64
65*25 2 1/2*1	76.1*33.7 3*1.327	2.07 300	60	64
65*32 2 3/4*1 1/4	76.1*42.4 3*1.66	2.07 300	60	64
65*40 2 3/4*1 1/2	76.1*48.3 3*1.9	2.07 300	60	64
65*50 2 3/4*2	76.1*60.3 3*2.375	2.07 300	58	64
80*15 3*1/2	88.9*21.3 3.5*0.825	2.07 300	64	64
80*20 3*3/4	88.9*26.9 3.5*1.05	2.07 300	64	64
80*25 3*1	88.9*33.7 3.5*1.327	2.07 300	60	64
80*32 3*1 1/4	88.9*42.4 3.5*1.66	2.07 300	60	64
80*40 3*1 1/2	88.9*48.3 3.5*1.9	2.07 300	60	64
80*50 3*2	88.9*60.3 3.5*2.375	2.07 300	60	64
80*65 3*2 1/2	88.9*73 3.5*2.875	2.07 300	60	64
80*85 3*2 1/2	88.9*76.1 3.5*3	2.07 300	60	64
100*25 4*1	108*33.7 4.252*1.327	2.07 300	65	76
100*32 4*1 1/4	108*42.4 4.252*1.66	2.07 300	65	76
100*40 4*1 1/2	108*48.3 4.252*1.9	2.07 300	65	76
100*50 4*2	108*60.3 4.252*2.375	2.07 300	65	76

Nominal size	Pipe O.D mm/in	Working Pressure Mpa/psi	Dimension mm/in	
规格	钢管尺寸	工作压力	L	
100*65 4*2 1/2	108*73 4.252*2.875	2.07 300	65	76
100*65 4*2 1/2	108*76.1 4.252*3	2.07 300	65	76
100*80 4*3	108*88.9 4.252*3.5	2.07 300	65	76
100*15 4*1/2	114.3*21.3 4.5*0.825	2.07 300	65	76
100*20 4*3/4	114.3*26.7 4.5*1.05	2.07 300	65	76
100*25 4*1	114.3*33.7 4.5*1.327	2.07 300	65	76
100*32 4*1 1/4	114.3*42.4 4.5*1.66	2.07 300	65	76
100*40 4*1 1/2	114.3*48.3 4.5*1.9	2.07 300	65	76
100*50 4*2	114.3*60.3 4.5*2.375	2.07 300	65	76
100*65 4*2 1/2	114.3*73 4.5*2.875	2.07 300	65	76
100*65 4*2 3/4	114.3*76.1 4.5*3	2.07 300	65	76
100*80 4*3	114.3*88.9 4.5*3.5	2.07 300	65	76
125*25 5*1	133*33.7 5.25*1.327	2.07 300	70	89
125*32 5*1 1/4	133*42.4 5.25*1.66	2.07 300	70	89
125*40 5*1 1/2	133*48.3 5.25*1.9	2.07 300	70	89
125*50 5*2	133*60.3 5.25*2.375	2.07 300	70	89
125*65 5*2 1/2	133*73 5.25*2.875	2.07 300	70	89
125*65 5*2 3/4	133*76.1 5.25*3	2.07 300	70	89
125*80 5*3	133*88.9 5.25*3.5	2.07 300	70	89
125*100 5*4	133*114.3 5.25*4.5	2.07 300	65	89
125*15 5*1/2	139.7*21.3 5.5*0.825	2.07 300	70	89
125*20 5*3/4	139.7*26.7 5.5*1.05	2.07 300	70	89
125*25 5*1	139.7*33.7 5.5*1.327	2.07 300	70	89
125*32 5*1 1/4	139.7*42.4 5.5*1.66	2.07 300	70	89
125*40 5*1 1/2	139.7*48.3 5.5*1.9	2.07 300	70	89
125*50 5*2	139.7*60.3 5.5*2.375	2.07 300	70	89
125*65 5*2 1/2	139.7*73 5.5*2.875	2.07 300	70	89
125*65 5*2 3/4	139.7*76.1 5.5*3	2.07 300	70	89
125*80 5*3	139.7*88.9 5.5*3.5	2.07 300	70	89
125*100 5*4	139.7*114.3 5.5*4.5	2.07 300	70	89
125*15 5*1/2	139.7*21.3 5.5*0.825	2.07 300	70	89
125*20 5*3/4	139.7*26.7 5.5*1.05	2.07 300	70	89



ISO9001:2008



ISO14001:2004



OHSAS18001:2007

PRODUCTS LIABILITY
INSURANCE POLICY SCHEDULE

XGQT07S

螺纹同心异径管

Threaded Concentric Reducer

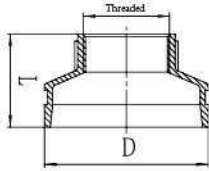

BSPT and NPT threads are also available, please specify when order.

Nominal size	Pipe O.D mm/in	Working Pressure Mpa/psi	Dimension mm/in	
规格	钢管尺寸	工作压力	L	
125*25 5*1	141.3*33.7 5.563*1.327	2.07 300	70	89
125*32 5*1 1/2	141.3*42.4 5.563*1.66	2.07 300	70	89
125*40 5*1 1/2	141.3*48.3 5.563*1.9	2.07 300	70	89
125*50 5*2	141.3*60.3 5.563*2.375	2.07 300	70	89
125*65 5*2 1/2	141.3*73 5.563*2.875	2.07 300	70	89
125*65 5*2 1/2	141.3*76.1 5.563*3	2.07 300	70	89
125*80 5*3	141.3*88.9 5.563*3.5	2.07 300	70	89
125*100 5*4	141.3*114.3 5.563*4.5	2.07 300	70	89
150*25 6*1	159*33.7 6.25*1.327	2.07 300	75	102
150*32 6*1 1/2	159*42.4 6.25*1.66	2.07 300	75	102
150*40 6*1 1/2	159*48.3 6.25*1.9	2.07 300	75	102
150*50 6*2	159*60.3 6.25*2.375	2.07 300	75	102
150*65 6*2 1/2	159*73 6.25*2.875	2.07 300	75	102
150*65 6*2 1/2	159*76.1 6.25*3	2.07 300	75	102
150*80 6*3	159*88.9 6.25*3.5	2.07 300	75	102
150*100 6*4	159*114.3 6.25*4.5	2.07 300	75	102
150*15 6* 1/2	165.1* 21.3 6.5*0.825	2.07 300	75	102
150*20 6* 1/2	165.1* 26.7 6.5*1.05	2.07 300	75	102
150*25 6*1	165.1*33.7 6.5*1.327	2.07 300	75	102
150*32 6*1 1/2	165.1*42.4 6.5*1.66	2.07 300	75	102
150*40 6*1 1/2	165.1*48.3 6.5*1.9	2.07 300	75	102
150*50 6*2	165.1*60.3 6.5*2.375	2.07 300	75	102
150*65 6*2 1/2	165.1*73 6.5*2.875	2.07 300	75	102
150*65 6*2 1/2	165.1*76.1 6.5*3	2.07 300	75	102
150*80 6*3	165.1*88.9 6.5*3.5	2.07 300	75	102
150*100 6*4	165.1*114.3 6.5*4.5	2.07 300	75	102
150*15 6* 1/2	168.3* 21.3 6.625*0.825	2.07 300	75	102
150*20 6* 1/2	168.3* 26.7 6.625*1.05	2.07 300	75	102
150*25 6*1	168.3*33.7 6.625*1.327	2.07 300	75	102
150*32 6*1 1/2	168.3*42.4 6.625*1.66	2.07 300	75	102
150*40 6*1 1/2	168.3*48.3 6.625*1.9	2.07 300	75	102
150*50 6*2	168.3*60.3 6.625*2.375	2.07 300	75	102

Nominal size	Pipe O.D mm/in	Working Pressure Mpa/psi	Dimension mm/in	
规格	钢管尺寸	工作压力	L	
150*65 6*2 1/2	168.3*73 6.625*2.875	2.07 300	75	102
150*65 6*2 1/2	168.3*76.1 6.625*3	2.07 300	75	102
150*80 6*3	168.3*88.9 6.625*3.5	2.07 300	75	102
150*100 6*4	168.3*114.3 6.625*4.5	2.07 300	75	102
200*100 8*4	216.3*114.3 8.516*4.5	2.07 300	85	127
200*50 8*2	219.1*60.3 8.625*2.375	2.07 300	85	127
200*65 8*2 1/2	219.1*73 8.625*2.875	2.07 300	85	127
200*65 8*2 1/2	219.1*76.1 8.625*3	2.07 300	85	127
200*80 8*3	219.1*88.9 8.625*3.5	2.07 300	85	127
200*100 8*4	219.1*114.3 8.625*4.5	2.07 300	85	127
250*100 10*4	273*114.3 10.75*4.5	2.07 300	90	172
300*100 12*4	323.9*114.3 12.75*4.5	2.07 300	90	178

XGQT08

转换法兰

Grooved Adaptor Flange

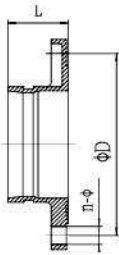

Nominal size	Pipe O.D mm/in	Dimension mm/in	PN10		PN16		PN25		ANSI 150		10K		20K		BS			
			D	Bolt size 螺栓规格	D	Bolt size 螺栓规格	D	Bolt size 螺栓规格	D	Bolt size 螺栓规格	D	Bolt size 螺栓规格	D	Bolt size 螺栓规格	D	Bolt size 螺栓规格		
规格	钢管尺寸	L																
25 1	33.7 1.327	60	85	4-M12	85	4-M12	85	4-M12	79.5	4-1/2								
32 1 1/4	42.4 1.66	60	100	4-M16	100	4-M16	100	4-M16	89	4-1/2								
40 1 1/2	48.3 1.9	60	110	4-M16	110	4-M16	110	4-M16	98.5	4-1/2	105	4-5/8	105	4-5/8				
50 2	60.3 2.375	65	125	4-M16	125	4-M16	125	4-M16	120.5	4-5/8	120	4-5/8	120	8-5/8				
65 2 1/2	73 2.875	60	145	4-M16	145	4-M16	145	8-M16	139.5	4-5/8								
65 2 1/2	76.1 3	65	145	4-M16	145	4-M16	145	8-M16	139.5	4-5/8	140	4-5/8	140	8-5/8	127	4-M16		
80 3	88.9 3.5	65	160	8-M16	160	8-M16	160	8-M16	152.5	8-5/8	150	8-5/8	160	8-3/4	148	4-M16		
100 4	108 4.252	65	180	8-M16	180	8-M16	190	8-M20										
100 4	114.3 4.5	70	180	8-M16	180	8-M16	190	8-M20	190.5	8-5/8	175	8-5/8	185	8-3/4	178	8-M16		
125 5	133 5.25	70	210	8-M16	210	8-M16	220	8-M24										
125 5	139.7 5.5	70	210	8-M16	210	8-M16	220	8-M24	216	8-3/4	210	8-3/4	225	8-7/8	210	8-M16		
125 5	141.3 5.563	70	210	8-M16	210	8-M16			216	8-3/4								
150 6	159 6.26	70	240	8-M20	240	8-M20	250	8-M24										
150 6	166.1 6.5	70	240	8-M20	240	8-M20	250	8-M24	241.5	8-3/4	240	8-3/4	260	12-7/8	235	8-M20		
150 6	168.3 6.625	70	240	8-M20	240	8-M20			241.5	8-3/4								
200 8	216.3 8.516	80									290	12-3/4	305	12-7/8				
200 8	219.1 8.625	80	295	8-M20	295	12-M20	310	12-M24	298.5	8-3/4					292	8-M20		
250 10	267.4 10.528	85									355	12-7/8	380	12-1				
250 10	273 10.75	85	350	12-M20	355	12-M20			362	12-7/8					356	12-M20		
300 12	318.5 12.539	90									400	12-7/8	430	16-1				
300 12	323.9 12.75	90	400	12-M20	410	12-M20			432	12-7/8					406	12-M22		
350 14	355.6 12.750	100							476	12-1					470	12-M22		
350 14	377.0 14.843	100			470	16-M20												
400 16	406.4 16.000	110							540	16-1					521	12-M22		
400 16	426.0 16.772	110			525	16-M24												
450 18	457.2 18.000	115							578	16-11/8					584	16-M22		
450 18	480 18.897	115			585	20-M24												
500 20	508.0 20.000	152			650	20-M24			635	20-11/8								
600 24	609.6 24.000	152			770	20-M27			749.5	20-11/4								

XGQT08S

丝接法兰

Threaded Flange

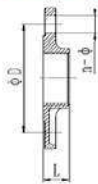

Nominal size	Pipe O.D mm/in	Dimension mm/in	PN10		PN16		PN25		ANSI 150		10K		20K		BS			
			D	Bolt size 螺栓规格	D	Bolt size 螺栓规格	D	Bolt size 螺栓规格	D	Bolt size 螺栓规格	D	Bolt size 螺栓规格	D	Bolt size 螺栓规格	D	Bolt size 螺栓规格		
规格	钢管尺寸	L																
25 1	33.7 1.327	30	85	4-M12	85	4-M12	85	4-M12	79.5	4-1/2								
32 1 1/4	42.4 1.66	30	100	4-M16	100	4-M16	100	4-M16	89	4-1/2								
40 1 1/2	48.3 1.9	30	110	4-M16	110	4-M16	110	4-M16	98.5	4-1/2	105	4-5/8	105	4-5/8				
50 2	60.3 2.375	30	125	4-M16	125	4-M16	125	4-M16	120.5	4-5/8	120	4-5/8	120	8-5/8				
65 2 1/2	73 2.875	35	145	4-M16	145	4-M16	145	8-M16	139.5	4-5/8								
65 2 1/2	76.1 3	35	145	4-M16	145	4-M16	145	8-M16	139.5	4-5/8	140	4-5/8	140	8-5/8	127	4-M16		
80 3	88.9 3.5	35	160	8-M16	160	8-M16	160	8-M16	152.5	8-5/8	150	8-5/8	160	8-3/4	146	4-M16		
100 4	114.3 4.5	40	180	8-M16	180	8-M16	190	8-M20	190.5	8-5/8	175	8-5/8	185	8-3/4	178	8-M16		



ISO9001:2008 ISO14001:2004 OHSAS18001:2007

PRODUCTS LIABILITY INSURANCE POLICY'S SCHEDULE

XGQT4

分体法兰

Grooved Split Flange

PN16

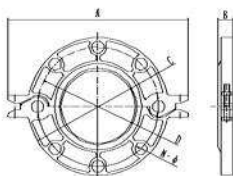

Nominal size 规格	Pipe O.D mm/in 钢管尺寸	Dimension mm/in				Bolt Size 螺栓规格	
		A	B	C	D		
40 1½	48.3 1.900	195	18.5	110	150	2-M1050	4-M16
50 2	60.3 2.375	220	22	125	165	2-M1060	4-M16
65 2½	73 2.875	238	22	145	185	2-M1060	4-M16
65 2½	76.1 3	238	22	145	185	2-M1060	4-M16
80 3	88.9 3.5	252	22	160	200	2-M1060	8-M16
100 4	108 4.25	278	22	180	220	2-M1065	8-M16
100 4	114.3 4.5	278	22	180	220	2-M1065	8-M16
125 5	133 5.25	318	23	210	250	2-M1065	8-M16
125 5	139.7 5.5	318	23	210	250	2-M1065	8-M16
125 5	141.3 5.563	318	23	210	250	2-M1065	8-M16
150 6	159 6.25	345	23	240	285	2-M10*6	8-M20
150 6	165.1 6.5	345	23	240	285	2-M10*6	8-M20
150 6	168.3 6.625	345	23	240	285	2-M10*6	8-M20
200 8	216.3 8.516	402	28	295	335	2-M1280	12-M20
200 8	219.1 8.625	410	28	295	340	2-M12*80	12-M20
250 10	267.4 10.528	496	29.5	355	400	2-M12*80	12-M24
250 10	273 10.75	500	29.5	355	405	2-M12*80	12-M24
300 12	318.5 12.539	545	29.5	410	452	2-M12*80	12-M24
300 12	323.9 12.75	550	29.5	410	460	2-M12*80	12-M24

XGQT4

ANSI 150

分体法兰

Grooved Split Flange

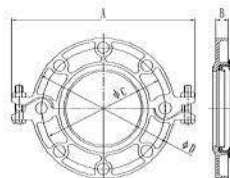

Nominal size 规格	Pipe O.D mm/in 钢管尺寸	Dimension mm/in				Bolt Size 螺栓规格	
		A	B	C	D		
50 2	60.3 2.375	220	22	120.5	155	2-M10*60	4-5/8
65 2½	73 2.875	238	22	139.5	180	2-M10*60	4-5/8
65 2½	76.1 3	238	22	139.5	190	2-M10*60	4-5/8
80 3	88.9 3.5	252	22	152.5	190	2-M10*60	4-5/8
100 4	114.3 4.5	278	22	190.5	230	2-M10*65	4-5/8
125 5	141.3 5.563	318	23	216	255	2-M10*65	8-3/4
150 6	165.1 6.5	345	23	241.5	280	2-M10*65	8-3/4
150 6	168.3 6.625	345	23	241.5	280	2-M10*65	8-3/4
200 8	219.1 8.625	410	28	298.5	345	2-M12*80	8-3/4
250 10	273 10.75	500	29.5	362	405	2-M12*80	12-7/8
300 12	323.9 12.75	550	29.5	432	485	2-M12*80	12-7/8



XGQT09

盲片

Cap

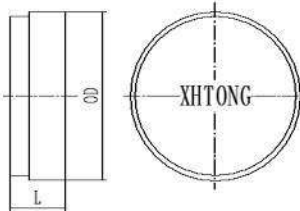

Nominal size	Pipe O.D mm/in	Working Pressure Mpa/psi	Dimension mm/in
规格	钢管尺寸	工作压力	L
25	33.7	2.07	25
1	1.315	300	
32	42.4	2.07	25
1¼	1.66	300	
40	48.3	2.07	25
1½	1.9	300	
50	60.3	2.07	25
2	2.375	300	
65	73	2.07	25
2½	2.875	300	
65	76.1	2.07	25
2½	3	300	
80	88.9	2.07	25
3	3.5	300	
100	108	2.07	28
4	4.252	300	
100	114.3	2.07	28
4	4.5	300	
125	133	2.07	28
5	5.25	300	
125	139.7	2.07	28
5	5.5	300	
125	141.3	2.07	28
5	5.563	300	
150	159	2.07	28
6	6.26	300	
150	165.1	2.07	28
6	6.5	300	
150	168.3	2.07	28
6	6.625	300	
200	216.3	2.07	32
8	8.516	300	
200	219.1	2.07	32
8	8.625	300	
250	267.4	2.07	34
10	10.528	300	
250	273	2.07	34
10	10.75	300	
300	318.5	2.07	34
12	12.539	300	
300	323.9	2.07	34
12	12.75	300	
350	355.6	2.07	102
14	14.000	300	
350	377.0	2.07	102
14	14.84	300	
400	406.4	2.07	102
16	16.000	300	
400	426.0	2.07	102
16	16.77	300	
450	457.2	2.07	127
18	18.000	300	
450	480.0	2.07	127
18	18.90	300	
500	508.0	2.07	152
20	20.000	300	
600	609.6	2.07	152
24	24.000	300	
600	630	2.07	152
24	24.80	300	



ISO9001:2008 ISO14001:2004 OHSAS18001:2007

PRODUCTS LIABILITY INSURANCE POLICY SCHEDULE

XGQT10

偏心带孔盲片

End Cap
with Eccentric Hole

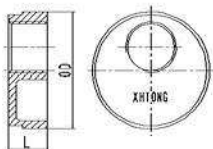

Nominal size	Pipe O.D mm/in	Working Pressure Mpa/psi	Dimension mm/in	Nominal size	Pipe O.D mm/in	Working Pressure Mpa/psi	Dimension mm/in
规格	钢管尺寸	工作压力	L	规格	钢管尺寸	工作压力	L
50X25 2X1	60.3 X33.7 2.375X1.315	2.07 300	25	125X32 5X1/4	141.3X42.4 5.563X1.66	2.07 300	28
50X32 2X1/4	60.3 X 42.4 2.375X 1.66	2.07 300	25	125X40 5X1/2	141.3 X 48.3 5.563X1.9	2.07 300	28
50X40 2X1/2	60.3 X 48.3 2.375X 1.9	2.07 300	25	125X50 5X2	141.3 X 60.3 5.563X2.375	2.07 300	28
65X25 2/2X1	73X33.7 2.875X1.315	2.07 300	25	150X25 6X1	165.1 X 33.7 6.5X1.315	2.07 300	28
50X32 2/2X 1/4	73X42.4 2.875X1.66	2.07 300	25	150X32 6X1/4	165.1 X 42.4 6.5X1.66	2.07 300	28
65X40 2/2X 1/2	73X48.3 2.875X1.9	2.07 300	25	150X40 6X1/2	165.1 X 48.3 6.5X1.9	2.07 300	28
65X25 2/2X1	76.1X33.7 3X1.315	2.07 300	25	150X50 6X2	165.1 X 60.3 5.5X2.375	2.07 300	28
50X32 2/2X 1/4	76.1 X 42.4 3X1.66	2.07 300	25	150X25 6X1	168.3 X 33.7 6.625X1.315	2.07 300	28
65X40 2/2X 1/2	76.1 X 48.3 3X1.9	2.07 300	25	150X32 6X1/4	168.3 X 42.4 6.625X1.66	2.07 300	28
65X50 2/2X 2	76.1X60.3 3X2.375	2.07 300	25	150X40 6X1/2	168.3 X 48.3 6.625X1.9	2.07 300	28
80X25 3X1	88.9 X33.7 3.5X1.315	2.07 300	25	150X50 6X2	168.3 X 60.3 6.625X2.375	2.07 300	28
80X32 3X1/4	88.9 X 42.4 3.5X1.66	2.07 300	25	200X25 8X1	219.1 X 33.7 8.625X1.315	2.07 300	32
80X40 3X1/2	88.9 X 48.3 3.5X1.9	2.07 300	25	200X32 8X1/4	219.1 X 42.4 8.625X1.66	2.07 300	32
80X50 3X2	88.9 X 60.3 3.5X2.375	2.07 300	25	200X40 8X1/2	219.1 X 48.3 8.625X1.9	2.07 300	32
100X25 4X1	114.3 X33.7 4.5X1.315	2.07 300	28	200X50 8X2	219.1 X 60.3 8.625X2.375	2.07 300	32
100X32 4X1/4	114.3 X 42.4 4.5X1.66	2.07 300	28	250X25 10X1	273X33.7 10.75X1.315	2.07 300	34
100X40 4X1/2	114.3 X 48.3 4.5X1.9	2.07 300	28	250X25 10X1/4	273X42.4 10.75X1.66	2.07 300	34
100X50 4X2	114.3 X 60.3 4.5X2.375	2.07 300	28	250X25 10X1/2	273X48.3 10.75X1.9	2.07 300	34
125X25 5X1	139.7X33.7 5.5X1.315	2.07 300	28	250X25 10X2	273X60.3 10.75X2.375	2.07 300	34
125*32 5X1/4	139.7X42.4 5.5X1.66	2.07 300	28	300X25 12X1	323.9X33.7 12.75X1.315	2.07 300	34
125X40 5X1/2	139.7 X 48.3 5.5X1.9	2.07 300	28	300X32 12X1/4	323.9X42.4 12.75 X1.66	2.07 300	34
125X50 5X2	139.7 X 60.3 5.5X2.375	2.07 300	28	300X40 12X1/2	323.9X48.3 12.75 X1.9	2.07 300	34
125X25 5X1	141.3X33.7 5.563X1.315	2.07 300	28	300X50 12X2	323.9X60.3 12.75 X2.375	2.07 300	34

XGQT10C

同心带孔盲片

End Cap
with Concentric Hole



Nominal size	Pipe O.D mm/in	Working Pressure Mpa/psi	Dimension mm/in	Nominal size	Pipe O.D mm/in	Working Pressure Mpa/psi	Dimension mm/in
规格	钢管尺寸	工作压力	L	规格	钢管尺寸	工作压力	L
50X25 2X1	60.3 X33.7 2.375X1.315	2.07 300	25	125X32 5X1 1/4	141.3X42.4 5.563X1.66	2.07 300	28
50X32 2X1 1/4	60.3 X 42.4 2.375X 1.66	2.07 300	25	125X40 5X1 1/2	141.3 X 48.3 5.563X1.9	2.07 300	28
50X40 2X1 1/2	60.3 X 48.3 2.375X 1.9	2.07 300	25	125X50 5X2	141.3 X 60.3 5.563X2.375	2.07 300	28
65X25 2 1/2 X1	73X33.7 2.875X1.315	2.07 300	25	150X25 6X1	165.1 X 33.7 6.5X1.315	2.07 300	28
50X32 2 1/2 X 1 1/4	73X42.4 2.875X1.66	2.07 300	25	150X32 6X1 1/4	165.1 X 42.4 6.5X1.66	2.07 300	28
65X40 2 1/2 X 1 1/2	73X48.3 2.875X1.9	2.07 300	25	150X40 6X1 1/2	165.1 X 48.3 6.5X1.9	2.07 300	28
65X25 2 1/2 X1	76.1X33.7 3X1.315	2.07 300	25	150X50 6X2	165.1 X 60.3 5.5X2.375	2.07 300	28
50X32 2 1/2 X 1 1/4	76.1 X 42.4 3X1.66	2.07 300	25	150X25 6X1	168.3 X 33.7 6.625X1.315	2.07 300	28
65X40 2 1/2 X 1 1/2	76.1 X 48.3 3X1.9	2.07 300	25	150X32 6X1 1/4	168.3 X 42.4 6.625X1.66	2.07 300	28
65X50 2 1/2 X 2	76.1X60.3 3X2.375	2.07 300	25	150X40 6X1 1/2	168.3 X 48.3 6.625X1.9	2.07 300	28
80X25 3X1	88.9 X33.7 3.5X1.315	2.07 300	25	150X50 6X2	168.3 X 60.3 6.625X2.375	2.07 300	28
80X32 3X1 1/4	88.9 X 42.4 3.5X1.66	2.07 300	25	200X25 8X1	219.1 X 33.7 8.625X1.315	2.07 300	32
80X40 3X1 1/2	88.9 X 48.3 3.5X1.9	2.07 300	25	200X32 8X1 1/4	219.1 X 42.4 8.625X1.66	2.07 300	32
80X50 3X2	88.9 X 60.3 3.5X2.375	2.07 300	25	200X40 8X1 1/2	219.1 X 48.3 8.625X1.9	2.07 300	32
100X25 4X1	114.3 X33.7 4.5X1.315	2.07 300	28	200X50 8X2	219.1 X 60.3 8.625X2.375	2.07 300	32
100X32 4X1 1/4	114.3 X 42.4 4.5X1.66	2.07 300	28	250X25 10X1	273X33.7 10.75X1.315	2.07 300	34
100X40 4X1 1/2	114.3 X 48.3 4.5X1.9	2.07 300	28	250X25 10X1 1/4	273X42.4 10.75X1.66	2.07 300	34
100X50 4X2	114.3 X 60.3 4.5X2.375	2.07 300	28	250X25 10X1 1/2	273X48.3 10.75X1.9	2.07 300	34
125X25 5X1	139.7X33.7 5.5X1.315	2.07 300	28	250X25 10X2	273X60.3 10.75X2.375	2.07 300	34
125X32 5X1 1/4	139.7X42.4 5.5X1.66	2.07 300	28	300X25 12X1	323.9 X33.7 12.75X1.315	2.07 300	34
125X40 5X1 1/2	139.7 X 48.3 5.5X1.9	2.07 300	28	300X32 12X1 1/4	323.9 X42.4 12.75X1.66	2.07 300	34
125X50 5X2	139.7 X 60.3 5.5X2.375	2.07 300	28	300X40 12X1 1/2	323.9 X48.3 12.75 X1.9	2.07 300	34
125X25 5X1	141.3X33.7 5.563X1.315	2.07 300	28	300X50 12X2	323.9 X60.3 12.75X2.375	2.07 300	34



ISO9001:2008

ISO14001:2004

OHSAS18001:2007

PRODUCTS LIABILITY
INSURANCE POLICY SCHEDULE

Y03

正Y型三通

Ture-Y

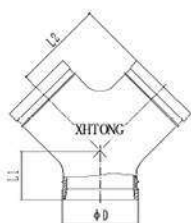

Nominal size 规格	Pipe O.D mm/in 钢管尺寸	Working Pressure Mpa/psi 工作压力	Dimension mm/in	
			L1	L2
50	60.3	2.07		
2	2.375	300	70	83
65	73	2.07		
2 1/2	2.875	300	76	95
65	76.1	2.07		
2 1/2	3	300	76	95
80	88.9	2.07		
3	3.5	300	83	108
100	114.3	2.5		
4	4.5	300	95	127
125	139.7	2.07		
5	5.5	300	102	140
125	141.3	2.07		
5	5.563	300	102	140
150	165.1	2.5		
6	6.5	300	114	165
150	168.3	2.5		
6	6.625	300	114	165
200	219.1	2.5		
8	8.625	300	152	197
250	273	2.5		
10	10.75	300	165	229
300	323.9	2.5		
12	12.75	300	178	254

TY03

沟槽顺水三通

Pitcher Tee

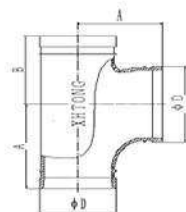

Nominal size 规格	Pipe O.D mm/in 钢管尺寸	Working Pressure Mpa/psi 工作压力	Dimension mm/in	
			A	B
100	114.3	2.5		
4	4.5	300	127	102
150	165.1	2.5		
6	6.5	300	165	140
150	168.3	2.5		
6	6.625	300	165	140
200	219.1	2.5		
8	8.625	300	197	175
250	273	2.5		
10	10.75	300	229	215
300	323.9	2.5		
12	12.75	300	266	245

TY04

沟槽顺水四通

Pitcher Cross

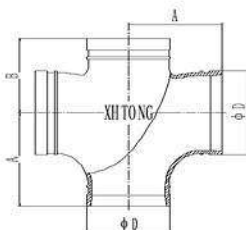

Nominal size 规格	Pipe O.D mm/in 钢管尺寸	Working Pressure Mpa/psi 工作压力	Dimension mm/in	
			A	B
100	114.3	2.5		
4	4.5	300	127	102
150	165.1	2.5		
6	6.5	300	165	140
150	168.3	2.5		
6	6.625	300	165	140
200	219.1	2.5		
8	8.625	300	197	175
250	273	2.5		
10	10.75	300	229	215
300	323.9	2.5		
12	12.75	300	266	245

TY05

沟槽异径顺水三通

Reducing Pitcher Tee

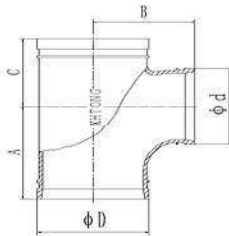

Nominal size 规格	Pipe O.D mm/in 钢管尺寸	Working Pressure Mpa/psi 工作压力	Dimension mm/in		
			A	B	C
150*80 6*3	168.3*88.9 6.625*3.5	2.07 300	110	146	96
150*100 6*4	168.3*114.3 6.625*4.5	2.07 300	140	153	102
200*80 8*3	219.1*88.9 8.625*3.5	2.07 300	110	175	96
200*100 8*4	219.1*114.3 8.625*4.5	2.07 300	140	188	114
250*100 10*4	273*114.3 10.75*4.5	2.07 300	140	220	114
250*200 10*8	273*219.1 10.75*8.625	2.07 300	215	230	185
300*80 12*3	323.9*88.9 12.75*3.5	2.07 300	122	246	96
300*100 12*4	323.9*114.3 12.75*4.5	2.07 300	140	246	114
300*150 12*6	323.9*165.1 12.75*6.5	2.07 300	175	246	144
300*150 12*6	323.9*168.3 12.75*6.625	2.07 300	175	246	144
300*200 12*8	323.9*219.1 12.75*8.625	2.07 300	215	266	185
300*250 12*10	323.9*273 12.75*10.75	2.07 300	245	260	215

TY06

沟槽异径顺水四通

Reducing Pitcher Cross

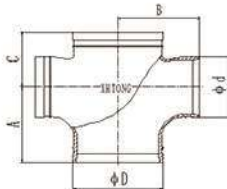

Nominal size 规格	Pipe O.D mm/in 钢管尺寸	Working Pressure Mpa/psi 工作压力	Dimension mm/in		
			A	B	C
150*100 6*4	168.3*114.3 6.625*4.5	2.07 300	140	153	102
200*100 8*4	219.1*114.3 8.625*4.5	2.07 300	140	188	114
300*100 12*4	323.9*114.3 12.75*4.5	2.07 300	140	246	114
300*150 12*6	323.9*165.1 12.75*6.5	2.07 300	175	246	144
300*150 12*6	323.9*168.3 12.75*6.625	2.07 300	175	246	144
300*250 12*10	323.9*273 12.75*10.75	2.07 300	245	260	215



XGQT12

外螺纹短接
Nipple

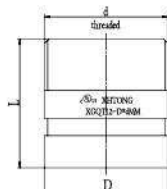

BSPT and NPT threads are also available, please specify when order.

Nominal size	Pipe O.D mm/in	Working Pressure Mpa/psi	Dimension mm/in
规格	钢管尺寸	工作压力	L
32*32	42.4* 42.4	2.07	60
1 ¹ / ₄ *1 ¹ / ₄	1.66*1.66	300	
40*40	48.3*48.3	2.07	60
1 ¹ / ₂ *1 ¹ / ₂	1.9*1.9	300	
50*50	60.3*60.3	2.07	66
2*2	2.375*1.9	300	
65*65	76.1*76.1	2.07	75
2 ¹ / ₂ *2 ¹ / ₂	3*1.327	300	
80*80	88.9*88.9	2.07	80
3*3	3.5*1.327	300	

橡胶密封圈 (GASKET DATA)

根据不同的环境和介质，选择不同的橡胶密封圈。



牌号标记 Gasket	名称 Name	适用温度 Temperature Range	使用介质 General Service Recommendations	颜色标记 Color Mark
E	三元乙丙橡胶 EPDM	-34~+110°C (-30~+230°F)	水、气体、稀释的酸(碱)、以及其他化学品(不包括碳氢化合物) 注: 严禁与油、碳氢化合物同用。 Water, air, dilute acids or base, and other chemicals(except hydrocarbon). Note: strictly prohibited usage with oil or hydrocarbon.	黑色加绿色标记 Green Strip
D	丁腈橡胶 NBR	-29~+82°C (-00~+180°F)	石油产品、植物油、矿物油 注: 严禁与高温物质同用。 (Recommended for petroleum products,air with oil vapors, vegetable and mineral oils within the specified temperature range. Not recommended for elevated temperature substances.)	黑色加橙色标记 Orange Strip
S	硅橡胶 Silicon Rubber	-40~+177°C (-40~+350°F)	高温干燥的空气和一些高温的化学物, 饮用水等。 (Recommended for high temperature dry air and some high temperature chemical products.)	白色 White

1 ANSI heavy hex nut

1.Material: SAE J995 2.
2.Thread: ANSI B 1.1-1982, class 2B.

d	F		G		H	
	Min	Max	Min	Max	Min	Max
3/8-16UNC	16.99	17.47	19.38	20.17	8.66	9.57
1/2-13UNC	21.59	22.22	24.61	25.65	11.78	12.80
5/8-11UNC	26.19	26.97	29.85	31.16	14.90	16.02
3/4-10UNC	30.78	31.75	35.10	35.65	18.03	19.25
7/8-9UNC	35.41	36.53	40.36	42.16	21.16	22.48



2 Metric heavy hex nut

1.Material: ISO 898-2:1992\GB/T3098.2-2000 Class 8.
2.Thread: ISO 261, tolerance 6h for M10&M12, 7h for M16 and above.

d	F		G	H	
	Min	Max	Min	Min	Max
M10	18.13	19	21.5	8.5	9.5
M12	20.16	21	22.78	11.9	12.3
M14	23.16	24	26.17	13.6	14.3
M16	26.16	27	29.56	16.4	17.1
M20	33	34	37.29	19.4	20.7
M22	22.3	23.6	39.55	22.3	23.6



3 Metric nut

d	F		G	H	
	Min	Max	Min	Min	Max
M10	15.73	16	17.77	8.04	8.4
M12	17.73	18	20.03	10.97	10.8
M14	20.67	21	23.36	12.1	12.8
M16	23.67	24	26.75	14.1	16.8
M20	29.16	30	32.95	16.9	18
M22	33	34	37.29	18.1	19.4



4 Hexagon Flange Nut

d	S		D	h	
	Min	Max	Max	Min	Max
M10	14.73	15.00	21.80	9.64	10.00
M12	17.73	18.00	26.00	11.57	12.00
M14	20.67	21.00	28.50	13.30	14.00
M16	23.67	24.00	33.00	15.30	16.00



1 ANSI Oval Neck Track Bolt

- 1. Material: SAE J429 5.
- 2. Thread: UNC thread per ANSI B 1.1 Class 2A.

d	A	C	F	H	L
3/8-16UNC	19	13.9	9.50	6.0	55/70
1/2-13UNC	22.5	16	12.70	8.0	70/75
5/8-11UCN	27.4	19.8	15.90	10.0	80/85/105
3/4-10UNC	32.5	26.2	19.05	12.0	115/120
7/8-9UNC	37.7	28.8	22.20	14.0	125/140



2 Metric Oval Neck Track Bolt

- 1. Material: ISO 898-1:1992\GB/T3098.1-2000 Class 8.8.
- 2. Thread: ISO metric thread per ISO 261, tolerance 6h.

d	A	C	F	H	L
M10	18.5	13.5	9.5	5	45/50/55/60
M12	23.5	17.5	12.3	8	60/65/70/75/80
M14	24	18	14	9.5	75/85/90
M16	29.5	20.5	15.7	10	85/90/100/120
M20	38	27	18.3	12.5	100/110/120/130
M22	42.2	31	21.4	14	90/100/120/130

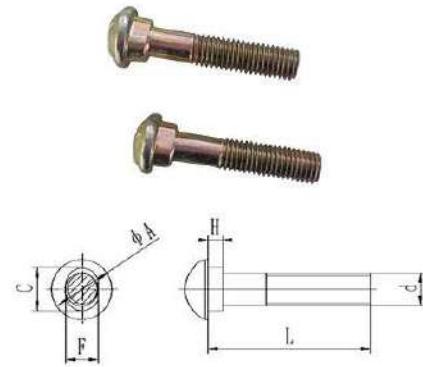

3 U- Bolt

d	L				
M10	52	54	65	75	92

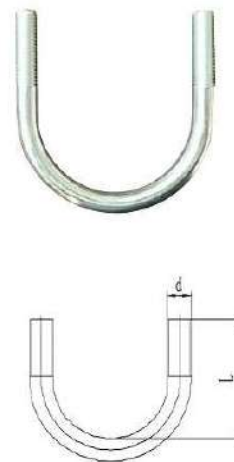

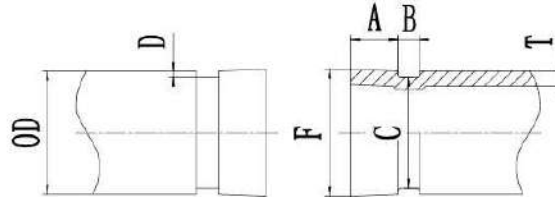
Roll Groove Dimension Standard

Nominal pipe Diameter	Pipe outer diameter		The size from pipe end to groove edge A ± 0.76	Groove width B ± 0.76	Groove diameter C		Groove depth D	Minimum thickness of the pipe wall T	Outer diameter of the maximum extension surface
	Actual size	Tolerance			Actual Size	Tolerance			
25	33.7	+0.41 -0.68	15.88	7.14	30.23	-0.38	1.60	1.8	34.5
32	42.4	+0.50 -0.60	15.88	7.14	38.99	-0.38	1.60	1.8	43.3
40	48.3	+0.44 -0.52	15.88	7.14	45.09	-0.38	1.60	1.8	49.4
50	60.3	+0.61 -0.61	15.88	8.74	57.15	-0.38	1.60	1.8	62.2
65	73.0	+0.74 -0.74	15.88	8.74	69.09	-0.46	1.98	2.3	75.2
65	76.1	+0.76 -0.76	15.88	8.74	72.26	-0.46	1.98	2.3	77.7
80	88.9	+0.89 -0.79	15.88	8.74	84.94	-0.46	1.98	2.3	90.6
90	101.6	+1.02 -0.79	15.88	8.74	97.38	-0.51	2.11	2.3	103.4
100	108.0	+1.07 -0.79	15.88	8.74	103.73	-0.51	2.11	2.3	109.7
100	114.3	+1.14 -0.79	15.88	8.74	110.08	-0.51	2.11	2.3	116.2
125	133.0	+1.32 -0.79	15.88	8.74	129.13	-0.51	2.11	2.9	134.9
125	139.7	+1.40 -0.79	15.88	8.74	135.48	-0.51	2.11	2.9	141.7
125	141.3	+1.42 -0.79	15.88	8.74	137.03	-0.56	2.13	2.9	143.5
150	159.0	+1.60 -0.79	15.88	8.74	154.50	-0.56	2.16	2.9	161.0
150	165.1	+1.60 -0.79	15.88	8.74	160.90	-0.56	2.16	2.9	167.1
150	168.3	+1.60 -0.79	15.88	8.74	163.96	-0.56	2.16	2.9	170.7
200	219.1	+1.60 -0.79	19.05	11.91	214.40	-0.64	2.34	2.9	221.5
250	273.0	+1.60 -0.79	19.05	11.91	268.28	-0.69	2.39	3.6	275.4
300	323.9	+1.60 -0.79	19.05	11.91	318.29	-0.76	2.77	4.0	326.2
350	355.6	+1.60 -0.79	23.8	12.7	350.0	-0.76	2.77	4.0	358.1
350	377.0	+1.60 -0.79	23.8	12.7	371.1	-0.76	2.77	4.0	379.5
400	406.4	+1.60 -0.79	23.8	12.7	400.8	-0.76	2.77	4.2	408.9
400	426.0	+1.60 -0.79	23.8	12.7	419.5	-0.76	2.77	4.2	428.5
450	457.2	+1.60 -0.79	25.4	12.7	451.6	-0.76	2.77	4.5	461.3
450	480.0	+1.60 -0.79	25.4	12.7	474.2	-0.76	2.77	4.5	484.1
500	508.0	+1.60 -0.79	25.4	12.7	502.4	-0.76	2.77	4.8	512.1
500	530.0	+1.60 -0.79	25.4	12.7	524.2	-0.76	2.77	4.8	534.2
600	609.6	+1.60 -0.79	25.4	14.3	600.9	-0.76	4.37	6.0	614.7
600	630.0	+1.60 -0.79	25.4	14.3	620.2	-0.76	4.37	6.0	635.1